

# 2

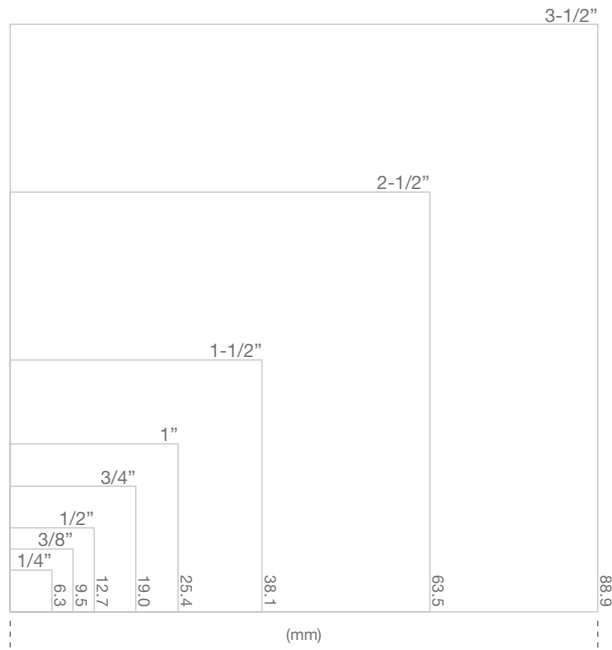

## ***Impact Socket***





### ***Impact Socket***

1/4 Inch Drive Impact Socket	068
3/8 Inch Drive Impact Socket	069
1/2 Inch Drive Impact Socket	071
3/4 Inch Drive Impact Socket	074
1 Inch Drive Impact Socket	078
1-1/2 Inch Drive Impact Socket	082
2-1/2 Inch Drive Impact Socket	084
3-1/2 Inch Drive Impact Socket	085

### ***12 Point Impact Socket***

086

### ***Stubby Impact Socket***

088

### ***Star Impact Socket***

091

### ***Universal Impact Socket***

094

### ***Magnetic Impact Socket***

097

### ***Impact Accessories***

Impact Extension Bar	098
Wobble Impact Extension Bar	099
Lock Impact Extension Bar	099
Magnetic Impact Extension Bar	100
Impact Universal Joint	100
Spinning Impact Extension Bar	101
Impact Adapter	102

### ***Impact Socket Set***

3/8 Inch Drive Impact Socket Set	103
1/2 Inch Drive Impact Socket Set	103
3/4 Inch Drive Impact Socket Set	109
1 Inch Drive Impact Socket Set	112

### ***Bits Impact Socket***

Hex Bit Impact Socket	114
Star Bit Impact Socket	117
Triple Square Tamperproof Bit Impact Socket	118
Triple Square Bit Impact Socket	119
Star Bit Impact Socket Set	120
Hex Bit Impact Socket Set	121

# IMPACT SOCKET

## Between American Standard (ANSI) and Euro Standard (DIN/ISO)

Most of impact socket are based on US. spec called ANSI/ASTM (American National Standards Institute) or German spec called DIN (Deutsches Institut für Normung). Here are the three major points.

- 1) ANSI/ASTM have standard for inch, but DIN have non.
- 2) Different diameter.
- 3) Different tolerance requirement.

## 1/4"DR. IMPACT SOCKET

### USA STYLE 1/4"DR. IMPACT SOCKET



1/4"

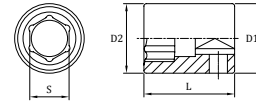
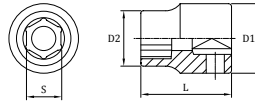

Item No.	S	L(mm)	D1(mm)	D2(mm)	G
IME26106	3/16"	23	13.0	8.4	12
IME26107	7/32"	23	13.0	9.4	12
IME26108	1/4"	23	13.0	10.3	13
IME26109	9/32"	23	13.0	11.3	13
IME26110	5/16"	23	13.0	12.3	13
IME26111	11/32"	23	14.0	14.0	17
IME26112	3/8"	23	14.4	14.4	17
IME26114	7/16"	23	17.0	17.0	26
IME26116	1/2"	23	19.0	19.0	32
IME26118	9/16"	23	20.0	20.0	34

Item No.	S	L(mm)	D1(mm)	D2(mm)	G
IME26204	4.0	23	13.0	7.5	12
IME262045	4.5	23	13.0	8.1	12
IME26205	5.0	23	13.0	8.7	12
IME262055	5.5	23	13.0	9.3	12
IME26206	6.0	23	13.0	9.9	13
IME26207	7.0	23	13.0	11.1	13
IME26208	8.0	23	13.0	12.3	13
IME26209	9.0	23	14.0	14.0	17
IME26210	10.0	23	14.4	14.4	16
IME26211	11.0	23	17.0	17.0	26
IME26212	12.0	23	18.0	18.0	28
IME26213	13.0	23	19.0	19.0	32
IME26214	14.0	23	20.0	20.0	35
IME26215	15.0	23	22.0	22.0	45

### USA STYLE 1/4"DR. DEEP IMPACT SOCKET



1/4"

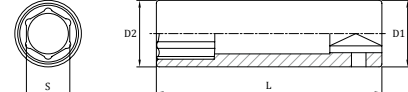
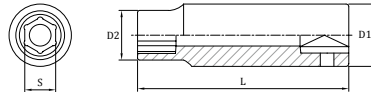

Item No.	S	L(mm)	D1(mm)	D2(mm)	G
ILME26106	3/16"	50	13.0	8.4	28
ILME26107	7/32"	50	13.0	9.4	29
ILME26108	1/4"	50	13.0	10.3	31
ILME26109	9/32"	50	13.0	11.3	31
ILME26110	5/16"	50	13.0	12.3	33
ILME26111	11/32"	50	13.2	13.2	33
ILME26112	3/8"	50	14.7	14.7	41
ILME26114	7/16"	50	16.0	16.0	48
ILME26116	1/2"	50	19.0	19.0	71
ILME26118	9/16"	50	20.0	20.0	76

Item No.	S	L(mm)	D1(mm)	D2(mm)	G
ILME26204	4.0	50	13.0	7.5	28
ILME262045	4.5	50	13.0	8.1	29
ILME26205	5.0	50	13.0	8.7	29
ILME262055	5.5	50	13.0	9.3	30
ILME26206	6.0	50	13.0	9.9	30
ILME26207	7.0	50	13.0	11.1	30
ILME26208	8.0	50	13.0	12.3	32
ILME26209	9.0	50	13.2	13.2	33
ILME26210	10.0	50	14.7	14.7	41
ILME26211	11.0	50	16.0	16.0	48
ILME26212	12.0	50	17.0	17.0	53
ILME26213	13.0	50	19.0	19.0	70
ILME26214	14.0	50	20.0	20.0	78
ILME26215	15.0	50	21.0	21.0	83

# 3/8"DR. IMPACT SOCKET

## USA STYLE 3/8"DR. IMPACT SOCKET



3/8"

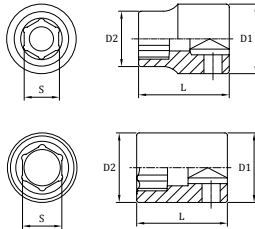

Item No.	S	L(mm)	D1(mm)	D2(mm)	G
IME36110	5/16"	29.5	19	12.6	32
IME36112	3/8"	29.5	19	14.6	34
IME36114	7/16"	29.5	19	17.1	36
IME36116	1/2"	29.5	20	20.0	43
IME36118	9/16"	29.5	21.5	21.5	56
IME36120	5/8"	30.0	23.5	23.5	67
IME36122	11/16"	30.0	24	24.0	64
IME36124	3/4"	30.0	26	26.0	72
IME36126	13/16"	30.0	28	28.0	88
IME36128	7/8"	30.0	30	30.0	97
IME36130	15/16"	30.0	32	32.0	112
IME36132	1"	30.0	34	34.0	133

Item No.	S	L(mm)	D1(mm)	D2(mm)	G
IME36207	7	29.5	19	11.4	32
IME36208	8	29.5	19	12.7	33
IME36209	9	29.5	19	14.0	34
IME36210	10	29.5	19	15.2	34
IME36211	11	29.5	19	17.0	37
IME36212	12	29.5	19	19.0	40
IME36213	13	29.5	20	20.0	44
IME36214	14	29.5	21	21.0	54
IME36215	15	29.5	22	22.0	53
IME36216	16	30.0	23	23.0	67
IME36217	17	30.0	24	24.0	66
IME36218	18	30.0	25	25.0	70
IME36219	19	30.0	26	26.0	72
IME36220	20	32.0	28	28.0	80
IME36221	21	32.0	28	28.0	80
IME36222	22	32.0	30	30.0	95
IME36223	23	32.0	31	31.0	110
IME36224	24	32.0	32	32.0	110

## USA STYLE 3/8"DR. DEEP IMPACT SOCKET



3/8"

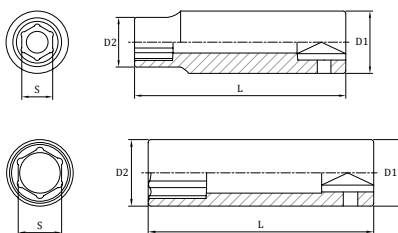

Item No.	S	L(mm)	D1(mm)	D2(mm)	G
ILME36110	5/16"	64	19.0	12.6	95
ILME36112	3/8"	64	19.0	14.6	94
ILME36114	7/16"	64	19.0	17.1	87
ILME36116	1/2"	64	20.0	20.0	96
ILME36118	9/16"	64	21.0	21.0	101
ILME36120	5/8"	64	23.5	23.5	113
ILME36122	11/16"	64	24.0	24.0	122
ILME36124	3/4"	64	26.0	26.0	148
ILME36126	13/16"	64	28.0	28.0	163
ILME36128	7/8"	64	30.0	30.0	197
ILME36130	15/16"	64	32.0	32.0	217
ILME36132	1"	64	34.0	34.0	248

Item No.	S	L(mm)	D1(mm)	D2(mm)	G
ILME36207	7	63	19.0	11.4	94
ILME36208	8	64	19.0	12.7	95
ILME36209	9	64	19.0	14.0	92
ILME36210	10	64	19.0	15.2	91
ILME36211	11	64	19.0	17.0	92
ILME36212	12	64	19.0	19.0	86
ILME36213	13	64	20.0	20.0	93
ILME36214	14	64	21.0	21.0	97
ILME36215	15	64	22.0	22.0	110
ILME36216	16	64	23.5	23.5	129
ILME36217	17	64	24.0	24.0	131
ILME36218	18	64	25.0	25.0	143
ILME36219	19	64	26.0	26.0	152
ILME36220	20	64	28.0	28.0	160
ILME36221	21	64	28.0	28.0	173
ILME36222	22	64	30.0	30.0	180
ILME36223	23	64	31.0	31.0	200
ILME36224	24	64	32	32.0	200

Socket & Wrench

Impact Socket

Air Chisels

Automotive Tools

# IMPACT SOCKET

## EURO STYLE 3/8"DR. IMPACT SOCKET



3/8"

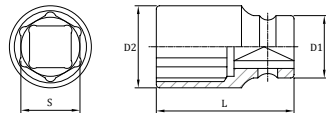
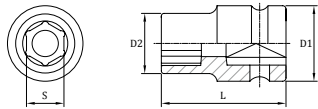

Item No.	S	L(mm)	D1(mm)	D2(mm)	G
IMO36207	7	29.5	19	11.4	30
IMO36208	8	29.5	19	12.7	31
IMO36209	9	29.5	19	14.0	33
IMO36210	10	29.5	19	15.2	33
IMO36211	11	29.5	19	17.0	33
IMO36212	12	29.5	19	18.0	35
IMO36213	13	29.5	19	20.0	39
IMO36214	14	29.5	19	21.0	46
IMO36215	15	29.5	19	22.0	43
IMO36216	16	30.0	22	23.5	58
IMO36217	17	30.0	22	24.0	57
IMO36218	18	30.0	22	25.0	57
IMO36219	19	30.0	22	26.0	56
IMO36220	20	30.0	22	28.0	80
IMO36221	21	30.0	22	28.0	80
IMO36222	22	30.0	22	30.0	95
IMO36224	24	30.0	22	32.0	110

## EURO STYLE 3/8"DR. DEEP IMPACT SOCKET



3/8"

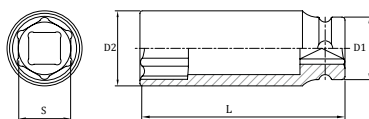
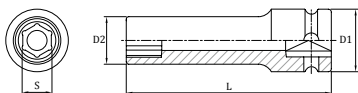

Item No.	S	L(mm)	D1(mm)	D2(mm)	G
ILMO36207	7	64	19	11.6	75
ILMO36208	8	64	19	12.7	77
ILMO36209	9	64	19	14.0	80
ILMO36210	10	64	19	15.2	75
ILMO36211	11	64	19	17.0	80
ILMO36212	12	64	19	18.0	79
ILMO36213	13	64	19	20.0	88
ILMO36214	14	64	19	21.0	94
ILMO36215	15	64	19	22.0	102
ILMO36216	16	64	22	23.0	108
ILMO36217	17	64	22	24.0	120
ILMO36218	18	64	22	25.0	120
ILMO36219	19	64	22	26.0	124
ILMO36220	20	64	22	28.0	140
ILMO36221	21	64	22	28.0	140
ILMO36222	22	64	22	30.0	160
ILMO36224	24	64	22	32.0	160

# 1/2"DR. IMPACT SOCKET

## USA STYLE 1/2"DR. IMPACT SOCKET



1/2"

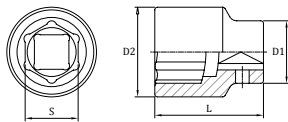
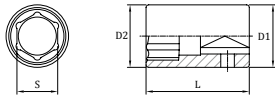
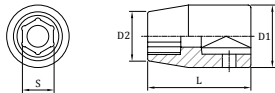

Item No.	S	L(mm)	D1(mm)	D2(mm)	G
IME46110	5/16"	38	22	14.5	50
IME46112	3/8"	38	22	16.0	66
IME46114	7/16"	38	22	18.0	65
IME46116	1/2"	38	22	20.0	63
IME46118	9/16"	38	24	22.0	79
IME46120	5/8"	38	25	25.0	88
IME46122	11/16"	38	26	26.0	95
IME46124	3/4"	38	28	28.0	106
IME46126	13/16"	38	30	30.0	123
IME46128	7/8"	38	32	32.0	145
IME46130	15/16"	38	34	34.0	162
IME46132	1"	38	36	36.0	187
IME46134	1-1/16"	40	38	38.0	217
IME46136	1-1/8"	40	38	40.0	223
IME46138	1-3/16"	40	38	42.0	234
IME46140	1-1/4"	40	38	44.0	250
IME46142	1-5/16"	43	38	45.0	286
IME46144	1-3/8"	43	38	47.0	323
IME46146	1-7/16"	43	38	48.0	322
IME46148	1-1/2"	45	39	52.0	358
IME46150	1-9/16"	45	44	54.0	393
IME46152	1-5/8"	45	44	56.0	427
IME46154	1-11/16"	60	44	60.0	665
IME46156	1-3/4"	60	44	62.0	703
IME46158	1-13/16"	70	44	64.0	854
IME46160	1-7/8"	70	44	66.0	903
IME46162	1-15/16"	70	44	68.0	972
IME46164	2"	70	52	70.0	1081
IME46166	2-1/16"	70	52	72.0	1116
IME46168	2-1/8"	70	52	74.0	1199
IME46170	2-3/16"	70	52	76.0	1181
IME46172	2-1/4"	70	52	78.0	1249

Item No.	S	L(mm)	D1(mm)	D2(mm)	G
IME46208	8	38	22	14.5	66
IME46209	9	38	22	15.6	66
IME46210	10	38	22	16.7	66
IME46211	11	38	22	18.0	65
IME46212	12	38	22	19.0	63
IME46213	13	38	24	20.2	81
IME46214	14	38	24	21.5	79
IME46215	15	38	25	23.0	87
IME46216	16	38	25	25.0	87
IME46217	17	38	26	26.0	94
IME46218	18	38	27	27.0	102
IME46219	19	38	28	28.0	105
IME46220	20	38	30	30.0	125
IME46221	21	38	30	30.0	121
IME46222	22	38	32	32.0	144
IME46223	23	38	33	33.0	154
IME46224	24	38	34	34.0	162
IME46225	25	42	36	36.0	201
IME46226	26	42	36.85	36.85	193
IME46227	27	42	38.3	38.3	224
IME46228	28	42	40	40.0	254
IME46229	29	42	41	41.0	265
IME46230	30	42	38	42.0	252
IME46231	31	42	38	44.0	276
IME46232	32	42	38	44.0	260
IME46233	33	43	38	46.0	299
IME46234	34	43	38	48.0	314
IME46235	35	48	38	48.0	322
IME46236	36	48	38	50.0	350
IME46238	38	48	38	52.0	380
IME46241	41	54	38	56.0	427
IME46246	46	60	38	62.0	854

Socket & Wrench

Impact Socket

Air Chisels

Automotive Tools

# IMPACT SOCKET

## USA STYLE 1/2"DR. DEEP IMPACT SOCKET



1/2"

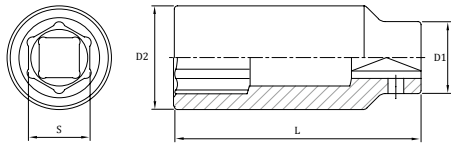
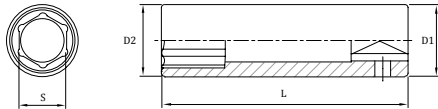
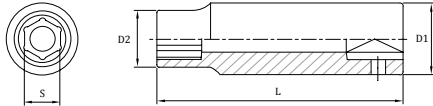

Item No.	S	L(mm)	D1(mm)	D2(mm)	G
ILME46112	3/8"	78	22	16	159
ILME46114	7/16"	78	22	18	151
ILME46116	1/2"	78	22	20	150
ILME46118	9/16"	78	24	22	168
ILME46120	5/8"	78	25	25	193
ILME46122	11/16"	78	26	26	210
ILME46124	3/4"	78	28	28	230
ILME46126	13/16"	78	30	30	246
ILME46128	7/8"	78	32	32	306
ILME46130	15/16"	78	34	34	343
ILME46132	1"	78	36	36	375
ILME46134	1-1/16"	78	38	38	434
ILME46136	1-1/8"	78	38	40	460
ILME46138	1-3/16"	78	38	42	506
ILME46140	1-1/4"	78	38	44	494
ILME46142	1-5/16"	78	38	45	503
ILME46144	1-3/8"	78	38	47	507
ILME46146	1-7/16"	78	38	48	566
ILME46148	1-1/2"	78	38	50	566
ILME46150	1-9/16"	78	44	54	679
ILME46152	1-5/8"	78	44	56	731
ILME46154	1-11/16"	93	44	60	1015
ILME46156	1-3/4"	93	44	62	1079
ILME46158	1-13/16"	93	44	64	1168
ILME46160	1-7/8"	93	44	66	1232
ILME46162	1-15/16"	93	44	68	1315
ILME46164	2"	93	52	70	1412
ILME46166	2-1/16"	93	52	72	1472
ILME46168	2-1/8"	93	52	74	1564
ILME46170	2-3/16"	93	52	76	1592
ILME46172	2-1/4"	93	52	78	1667

Item No.	S	L(mm)	D1(mm)	D2(mm)	G
ILME46208	8	78	22	14.5	140
ILME46209	9	78	22	15.6	140
ILME46210	10	78	22	16.7	152
ILME46211	11	78	22	18.0	155
ILME46212	12	78	22	19.0	150
ILME46213	13	78	24	20.2	175
ILME46214	14	78	24	21.5	168
ILME46215	15	78	24	24.0	171
ILME46216	16	78	25	25.0	193
ILME46217	17	78	26	26.0	190
ILME46218	18	78	26	26.0	180
ILME46219	19	78	28	28.0	220
ILME46220	20	78	30	30.0	260
ILME46221	21	78	30	30.0	245
ILME46222	22	78	32	32.0	286
ILME46223	23	78	32	32.0	276
ILME46224	24	78	34	34.0	314
ILME46225	25	78	36	36.0	360
ILME46226	26	78	36	36.0	362
ILME46227	27	78	38	38.0	405
ILME46228	28	78	40	40.0	446
ILME46229	29	78	40	40.0	435
ILME46230	30	78	38	42.0	453
ILME46231	31	78	38	44.0	470
ILME46232	32	78	38	44.0	495
ILME46233	33	78	38	46.0	470
ILME46234	34	78	38	46.0	552
ILME46235	35	78	38	48.0	570
ILME46236	36	78	38	50.0	587

## EURO STYLE 1/2"DR. IMPACT SOCKET



1/2"

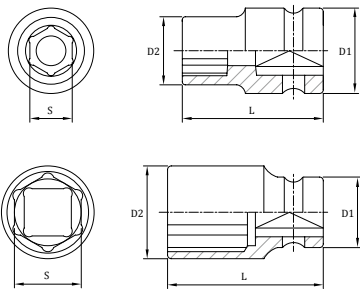

Item No.	S	L(mm)	D1(mm)	D2(mm)	G
IMO46208	8	38	25.0	14.5	67
IMO46209	9	38	25.0	15.6	68
IMO46210	10	38	25.0	16.7	68
IMO46211	11	38	25.0	18.0	70
IMO46212	12	38	25.0	19.0	71
IMO46213	13	38	25.0	20.2	72
IMO46214	14	38	25.0	21.5	74
IMO46215	15	38	25.0	23.0	76
IMO46216	16	38	25.0	24.5	77
IMO46217	17	38	25.0	26.0	87
IMO46218	18	38	25.0	27.0	84
IMO46219	19	38	25.0	28.0	87
IMO46220	20	38	25.0	30.0	90
IMO46221	21	38	25.0	30.0	94
IMO46222	22	38	30.0	32.0	128
IMO46223	23	38	30.0	34.0	130
IMO46224	24	38	30.0	34.0	131
IMO46225	25	42	30.0	36.0	162
IMO46226	26	42	30.0	38.0	157
IMO46227	27	42	30.0	40.0	173
IMO46228	28	42	30.0	40.0	175
IMO46229	29	42	30.0	42.0	188
IMO46230	30	42	30.5	42.0	192
IMO46231	31	42	30.0	44.0	195
IMO46232	32	42	30.0	44.0	201
IMO46233	33	48	35.0	46.0	279
IMO46234	34	48	35.0	48.0	301
IMO46235	35	48	35.0	50.0	312
IMO46236	36	48	35.0	50.0	318
IMO46238	38	48	35.0	52.0	341
IMO46239	39	48	35.0	54.0	354
IMO46241	41	54	35.0	56.0	421
IMO46246	46	60	35.0	62.0	543

Socket & Wrench

Impact Socket

Air Chisels

Automotive Tools

## EURO STYLE 1/2"DR. DEEP IMPACT SOCKET



1/2"

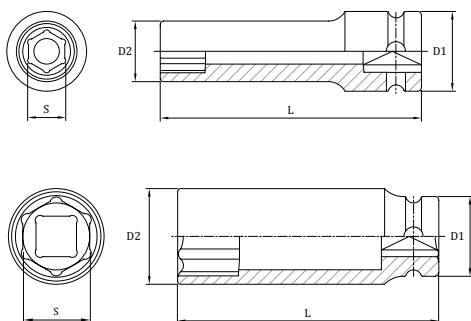

Item No.	S	L(mm)	D1(mm)	D2(mm)	G
ILMO46208	8	78	25	14.5	115
ILMO46209	9	78	25	15.6	120
ILMO46210	10	78	25	16.7	128
ILMO46211	11	78	25	18.0	133
ILMO46212	12	78	25	19.0	141
ILMO46213	13	78	25	20.2	150
ILMO46214	14	78	25	21.5	154
ILMO46215	15	78	25	23.0	170
ILMO46216	16	78	25	24.0	172
ILMO46217	17	78	25	26.0	200
ILMO46218	18	78	25	27.0	215
ILMO46219	19	78	25	28.0	225
ILMO46220	20	78	25	29.0	235
ILMO46221	21	78	25	30.0	243
ILMO46222	22	78	30	32.0	290
ILMO46223	23	78	30	33.0	292
ILMO46224	24	78	30	34.0	314
ILMO46225	25	78	30	36.0	351
ILMO46226	26	78	30	36.0	321
ILMO46227	27	78	30	38.0	389
ILMO46228	28	78	30	40.0	400
ILMO46229	29	78	30	41.0	426
ILMO46230	30	78	30	42.0	453
ILMO46231	31	78	30	43.0	440
ILMO46232	32	78	30	44.0	484
ILMO46233	33	78	35	46.0	471
ILMO46234	34	78	35	48.0	528
ILMO46235	35	78	35	49.0	533
ILMO46236	36	78	35	50.0	548
ILMO46238	38	78	35	52.0	552
ILMO46241	41	78	35	56.0	629



# IMPACT SOCKET

## 3/4" DR. IMPACT SOCKET

### USA STYLE 3/4" DR. IMPACT SOCKET



3/4"

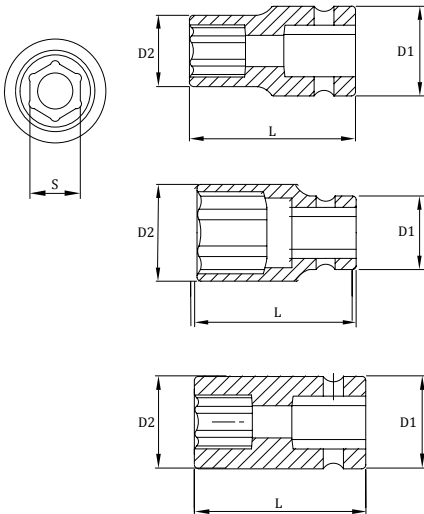

Item No.	S	L(mm)	D1(mm)	D2(mm)	G
IME66120	5/8"	50	38	27.5	220
IME66122	11/16"	50	38	29.0	230
IME66124	3/4"	50	38	30.0	240
IME66126	13/16"	52	38	32.0	250
IME66128	7/8"	52	38	34.0	290
IME66130	15/16"	52	38	36.0	300
IME66132	1"	52	40	40.0	330
IME66134	1-1/16"	52	40	40.0	350
IME66136	1-1/8"	52	42	42.0	390
IME66138	1-3/16"	52	44	44.0	400
IME66140	1-1/4"	52	44	44.0	460
IME66142	1-5/16"	56	44	47.0	460
IME66144	1-3/8"	56	44	50.0	500
IME66146	1-7/16"	56	44	51.0	510
IME66148	1-1/2"	56	44	53.0	520
IME66150	1-9/16"	62	44	56.0	580
IME66152	1-5/8"	62	44	58.0	600
IME66154	1-11/16"	62	44	63.5	630
IME66156	1-3/4"	62	44	65.0	730
IME66158	1-13/16"	68	44	67.0	730
IME66160	1-7/8"	68	44	68.0	800
IME66162	1-15/16"	70	44	70.0	840
IME66164	2"	72	54	71.0	840
IME66166	2-1/16"	72	54	74.0	1080
IME66168	2-1/8"	72	54	77.0	1200
IME66170	2-3/16"	74	54	77.0	1240
IME66172	2-1/4"	74	54	80.0	1290
IME66174	2-5/16"	75	54	82.0	1400
IME66176	2-3/8"	75	54	84.0	1580
IME66178	2-7/16"	75	54	85.0	1600
IME66180	2-1/2"	75	54	86.0	1680
IME66182	2-9/16"	78	62	89.0	1820
IME66184	2-5/8"	80	62	91.0	1840
IME66186	2-11/16"	80	62	93.0	1840
IME66188	2-3/4"	82	62	95.0	2140
IME66190	2-13/16"	82	62	98.0	2170
IME66192	2-7/8"	82	62	100.0	2230
IME66194	2-15/16"	85	62	102.0	2270
IME66196	3"	87	62	104.0	2340

Item No.	S	L(mm)	D1(mm)	D2(mm)	G
IME66217	17	50	38	28	220
IME66219	19	50	38	30	240
IME66220	20	52	38	31	250
IME66221	21	52	38	32	250
IME66222	22	52	38	34	290
IME66223	23	52	38	35	290
IME66224	24	52	38	36	300
IME66225	25	52	38	38	330
IME66226	26	52	40	40	340
IME66227	27	52	40	40	350
IME66228	28	52	42	42	380
IME66229	29	52	42	42	390
IME66230	30	52	44	44	400
IME66232	32	56	44	44	460
IME66233	33	56	44	47	460
IME66234	34	56	44	48	470
IME66235	35	56	44	50	500
IME66236	36	56	44	51	510
IME66238	38	56	44	53	520

# USA STYLE 3/4" DR DEEP IMPACT SOCKETS



3/4"

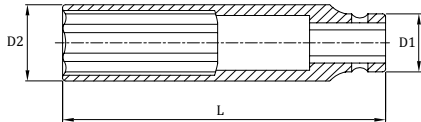
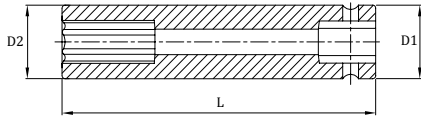
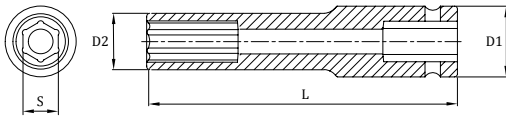

Item No.	S	L(mm)	D1(mm)	D2(mm)	G
ILME66120	5/8"	85	38	27.5	380
ILME66122	11/16"	85	38	29.0	400
ILME66124	3/4"	85	38	30.0	420
ILME66126	13/16"	85	38	32.0	450
ILME66128	7/8"	85	38	34.0	490
ILME66130	15/16"	85	38	36.0	530
ILME66132	1"	85	40	40.0	550
ILME66134	1-1/16"	85	40	40.0	580
ILME66136	1-1/8"	85	42	42.0	630
ILME66138	1-3/16"	85	44	44.0	680
ILME66140	1-1/4"	85	44	44.0	740
ILME66142	1-5/16"	85	44	47.0	760
ILME66144	1-3/8"	85	44	50.0	800
ILME66146	1-7/16"	85	44	51.0	840
ILME66148	1-1/2"	85	44	53.0	880
ILME66150	1-9/16"	85	44	58.0	940
ILME66152	1-5/8"	85	44	58.0	970
ILME66154	1-11/16"	85	44	63.5	1000
ILME66156	1-3/4"	85	44	65.0	1180
ILME66158	1-13/16"	85	44	67.0	1180
ILME66160	1-7/8"	85	44	68.0	1250
ILME66162	1-15/16"	85	44	70.0	1350
ILME66164	2"	85	54	71.0	1400
ILME66166	2-1/16"	95	54	74.0	1580
ILME66176	2-3/8"	95	54	84.0	2070
ILME66180	2-1/2"	95	54	86.0	2150

Item No.	S	L(mm)	D1(mm)	D2(mm)	G
ILME66219	19	85	38	30	420
ILME66220	20	85	38	31	430
ILME66221	21	85	38	32	450
ILME66222	22	85	38	34	490
ILME66223	23	85	38	35	520
ILME66224	24	85	38	36	530
ILME66225	25	85	38	38	540
ILME66226	26	85	40	40	560
ILME66227	27	85	40	40	580
ILME66228	28	85	42	42	630
ILME66229	29	85	42	42	630
ILME66230	30	85	44	44	680
ILME66232	32	85	44	44	740
ILME66233	33	85	44	47	760
ILME66234	34	85	44	49	790
ILME66235	35	85	44	50	800
ILME66236	36	85	44	51	840
ILME66238	38	85	44	53	880

Socket & Wrench

Impact Socket

Air Chisels

Automotive Tools

# IMPACT SOCKET

## EURO STYLE 3/4" DR. IMPACT SOCKET



3/4"

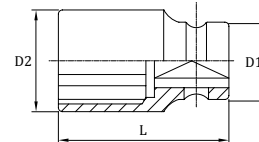
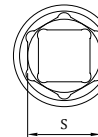
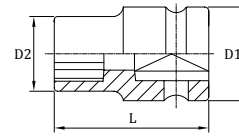
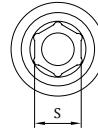

Item No.	S	L(mm)	D1(mm)	D2(mm)	G
IMO66118	9/16"	51	42.0	25.5	274
IMO66120	5/8"	51	42.0	28.5	282
IMO66122	11/16"	51	42.0	29.5	286
IMO66124	3/4"	51	42.0	32	303
IMO66126	13/16"	51	42.0	35.0	313
IMO66128	7/8"	51	42.0	36.0	312
IMO66130	15/16"	51	42.0	38.5	321
IMO66132	1"	53	42.0	40.0	335
IMO66134	1-1/16"	53	44.0	42.5	384
IMO66136	1-1/8"	53	44.0	44.0	359
IMO66138	1-3/16"	53	44.0	46.0	387
IMO66140	1-1/4"	57	44.0	48.5	445
IMO66142	1-5/16"	57	44.0	50.0	452
IMO66144	1-3/8"	57	44.0	52.5	492
IMO66146	1-7/16"	57	44.0	53.5	504
IMO66148	1-1/2"	57	44.0	56.0	532
IMO66150	1-9/16"	58	44.0	58.5	570
IMO66152	1-5/8"	58	44.0	60.0	580
IMO66154	1-11/16"	62	44.0	64.0	718
IMO66156	1-3/4"	62	44.0	64.0	644
IMO66158	1-13/16"	62	44.0	66.0	709
IMO66160	1-7/8"	68	44.0	68.0	825
IMO66162	1-15/16"	68	44.0	70.0	875
IMO66164	2"	68	44.0	71.0	838
IMO66166	2-1/16"	71	54.0	73.0	1036
IMO66168	2-1/8"	71	54.0	75.5	1098
IMO66170	2-3/16"	71	54.0	77.5	1115
IMO66172	2-1/4"	73	54.0	80.0	1240
IMO66174	2-5/16"	73	54.0	81.0	1230
IMO66176	2-3/8"	75	54.0	83.0	1221
IMO66178	2-7/16"	75	54.0	84.5	1280
IMO66180	2-1/2"	75	54.0	86.5	1309

Item No.	S	L(mm)	D1(mm)	D2(mm)	G
IMO66217	17	51	44	30.0	330
IMO66218	18	51	44	31.0	330
IMO66219	19	51	44	32.0	331
IMO66220	20	51	44	33.5	333
IMO66221	21	51	44	35.0	353
IMO66222	22	51	44	36.0	361
IMO66223	23	51	44	37.5	355
IMO66224	24	51	44	38.5	349
IMO66225	25	53	44	40.0	366
IMO66226	26	53	44	41.0	367
IMO66227	27	53	44	42.5	379
IMO66228	28	53	44	44.0	398
IMO66229	29	53	44	45.0	400
IMO66230	30	53	44	46.0	401
IMO66231	31	57	44	47.0	440
IMO66232	32	57	44	48.0	445
IMO66233	33	57	44	50.0	475
IMO66234	34	57	44	51.0	475
IMO66235	35	57	44	52.0	481
IMO66236	36	57	44	53.0	482
IMO66237	37	57	44	55.0	518
IMO66238	38	57	44	56.0	533
IMO66239	39	58	44	57.0	538
IMO66240	40	58	44	58.0	560
IMO66241	41	58	44	59.0	561
IMO66242	42	58	44	61.0	582
IMO66243	43	62	44	62.0	639
IMO66244	44	62	44	64.0	697
IMO66245	45	62	44	65.0	718
IMO66246	46	62	44	66.0	753
IMO66247	47	68	44	68.0	834
IMO66248	48	68	44	69.0	865
IMO66249	49	68	44	70.0	837
IMO66250	50	68	44	71.0	880
IMO66252	52	72	44	74.0	977
IMO66254	54	72	44	76.0	1012
IMO66255	55	72	54	77.5	1217
IMO66256	56	74	54	79.0	1240
IMO66257	57	74	54	80.0	1312
IMO66259	59	75	54	82.0	1300
IMO66260	60	75	54	84.0	1386
IMO66263	63	75	54	86.0	1379
IMO66265	65	78	54	88.0	1490
IMO66267	69	82	60	92.0	1763
IMO66270	70	85	60	95.0	1929

# EURO STYLE 3/4"DR. DEEP IMPACT SOCKET



3/4"

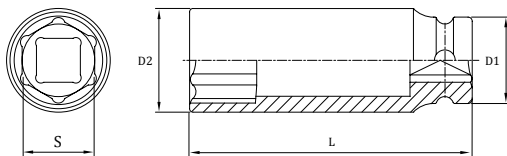
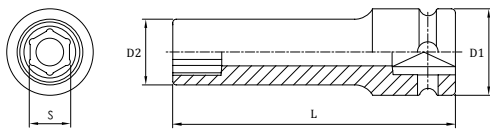

Item No.	S	L(mm)	D1(mm)	D2(mm)	G
ILMO66124	3/4"	90	42	32.5	480
ILMO66126	13/16"	90	42	35.0	510
ILMO66128	7/8"	90	42	36.0	550
ILMO66130	15/16"	90	42	38.5	580
ILMO66132	1"	90	42	40.0	610
ILMO66134	1-1/16"	90	44	42.5	630
ILMO66136	1-1/8"	90	44	44.0	650
ILMO66138	1-3/16"	90	44	46.0	700
ILMO66140	1-1/4"	90	44	48.5	740
ILMO66142	1-5/16"	90	44	50.0	760
ILMO66144	1-3/8"	90	44	52.5	840
ILMO66146	1-7/16"	90	44	53.5	850
ILMO66148	1-1/2"	90	44	56.0	880
ILMO66150	1-9/16"	90	44	58.5	910
ILMO66152	1-5/8"	90	44	60.0	950
ILMO66154	1-11/16"	90	44	63.0	990
ILMO66156	1-3/4"	90	44	64.5	1040
ILMO66158	1-13/16"	90	44	66.0	1080
ILMO66160	1-7/8"	90	44	68.0	1200
ILMO66162	1-15/16"	90	44	70.0	1220

Item No.	S	L(mm)	D1(mm)	D2(mm)	G
ILMO66217	17	90	44	30.0	490
ILMO66218	18	90	44	31.0	500
ILMO66219	19	90	44	32.0	510
ILMO66220	20	90	44	33.0	520
ILMO66221	21	90	44	34.5	530
ILMO66222	22	90	44	35.5	560
ILMO66223	23	90	44	37.5	570
ILMO66224	24	90	44	38.3	580
ILMO66225	25	90	44	39.5	610
ILMO66226	26	90	44	40.7	620
ILMO66227	27	90	44	42.0	630
ILMO66228	28	90	44	44.0	650
ILMO66229	29	90	44	45.0	670
ILMO66230	30	90	44	46.0	700
ILMO66232	32	90	44	48.0	740
ILMO66233	33	90	44	50.0	770
ILMO66234	34	90	44	51.0	800
ILMO66235	35	90	44	52.0	840
ILMO66236	36	90	44	53.0	850
ILMO66238	38	90	44	56.0	880
ILMO66240	40	90	44	58.0	880
ILMO66241	41	90	44	59.0	950
ILMO66242	42	90	44	61.0	980
ILMO66243	43	90	44	63.0	1026
ILMO66245	45	90	44	65.0	1090
ILMO66246	46	90	44	66.0	1100
ILMO66248	48	90	44	69.0	1161
ILMO66250	50	90	44	71.0	1240
ILMO66255	55	90	54	77.5	1503
ILMO66260	60	95	54	84.0	1763
ILMO66265	65	95	54	88.0	1796

Socket & Wrench

Impact Socket

Air Chisels

Automotive Tools

# IMPACT SOCKET

## 1"DR. IMPACT SOCKET

### USA STYLE 1"DR. IMPACT SOCKET

6

1"

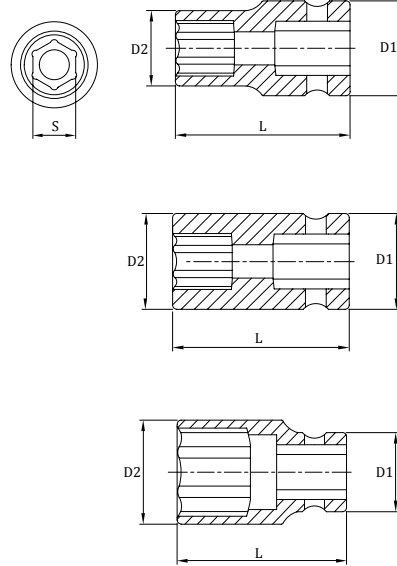

Item No.	S	L(mm)	D1(mm)	D2(mm)	G
IME86219	19	58	51	36.0	500
IME86221	21	58	51	38.0	510
IME86222	22	58	51	39.0	520
IME86223	23	58	51	40.0	520
IME86224	24	58	51	40.0	530
IME86225	25	58	51	41.0	530
IME86226	26	58	51	42.5	540
IME86227	27	58	51	44.0	550
IME86228	28	58	51	45.0	560
IME86229	29	60	51	46.0	560
IME86230	30	60	51	48.0	580
IME86232	32	60	51	51.0	650
IME86233	33	62	52	53.0	670
IME86234	34	62	52	54.0	700
IME86235	35	62	52	54.0	700
IME86236	36	62	52	56.0	750
IME86237	37	62	52	58.0	750
IME86238	38	62	52	58.0	800
IME86240	40	62	52	60.0	850
IME86241	41	62	52	61.5	900
IME86242	42	64	52	63.0	920
IME86246	46	64	58	68.0	1020
IME86250	50	70	58	73.0	1080
IME86252	52	70	58	75.0	1300
IME86254	54	70	58	78.0	1400
IME86255	55	72	62	79.0	1580
IME86256	56	74	62	80.0	1580
IME86258	58	75	62	85.0	1700
IME86260	60	78	62	87.0	1960
IME86265	65	80	62	93.0	2300

# USA STYLE 1"DR. DEEP IMPACT SOCKET



1"

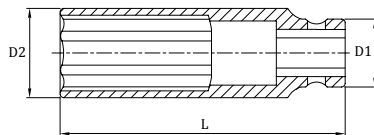
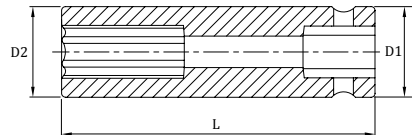
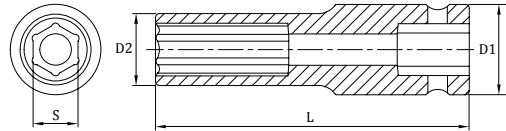

Socket & Wrench

Impact Socket

Air Chisels

Automotive Tools

Item No.	S	L(mm)	D1(mm)	D2(mm)
ILME86124	3/4"	90	51	36
ILME86126	13/16"	90	51	38
ILME86128	7/8"	90	51	39
ILME86130	15/16"	90	51	40
ILME86132	1"	90	51	42
ILME86134	1-1/16"	90	51	44
ILME86136	1-1/8"	90	51	46
ILME86138	1-3/16"	90	51	48
ILME86140	1-1/4"	90	51	51
ILME86142	1-5/16"	90	52	53
ILME86144	1-3/8"	90	52	54
ILME86146	1-7/16"	90	52	56
ILME86148	1-1/2"	92	52	58
ILME86150	1-9/16"	92	52	60
ILME86152	1-5/8"	92	52	61.5
ILME86154	1-11/16"	92	52	65
ILME86156	1-3/4"	92	58	66
ILME86158	1-13/16"	92	58	68
ILME86160	1-7/8"	92	58	70
ILME86162	1-15/16"	92	58	72
ILME86164	2"	95	58	74
ILME86166	2-1/16"	95	58	75
ILME86168	2-1/8"	95	58	78
ILME86170	2-3/16"	100	62	80
ILME86172	2-1/4"	100	62	84
ILME86174	2-5/16"	105	62	86
ILME86176	2-3/8"	105	62	87
ILME86178	2-7/16"	110	62	89
ILME86180	2-1/2"	110	62	91
ILME86182	2-9/16"	120	62	93

Item No.	S	L(mm)	D1(mm)	D2(mm)	G
ILME86219	19	90	51	36.0	620
ILME86221	21	90	51	38.0	670
ILME86222	22	90	51	39.0	700
ILME86223	23	90	51	40.0	730
ILME86224	24	90	51	40.0	740
ILME86225	25	90	51	41.0	750
ILME86226	26	90	51	42.5	760
ILME86227	27	90	51	44.0	800
ILME86228	28	90	51	45.0	810
ILME86229	29	90	51	46.0	840
ILME86230	30	90	51	48.0	840
ILME86232	32	90	51	51	900
ILME86233	33	90	52	53.0	950
ILME86235	35	90	52	54.0	1000
ILME86236	36	90	52	56.0	1000
ILME86238	38	92	52	58.0	1100
ILME86240	40	92	52	60.0	1100
ILME86241	41	92	52	61.5	1180
ILME86242	42	92	52	63.0	1200
ILME86246	46	92	58	68	1500
ILME86250	50	95	58	73	1680
ILME86252	52	95	58	75	1700
ILME86254	54	95	58	78	1750
ILME86255	55	100	62	79	2000

# IMPACT SOCKET

## EURO STYLE 1"DR. IMPACT SOCKET



1"

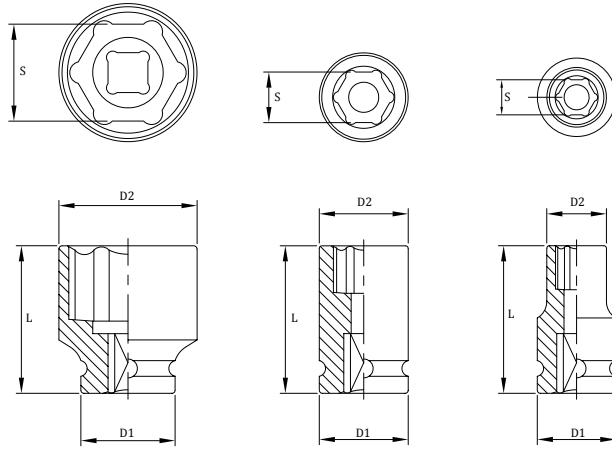

Item No.	S	L(mm)	D1(mm)	D2(mm)	G
IMO86124	3/4"	58	54.0	35.0	500
IMO86126	13/16"	58	54.0	37.0	500
IMO86128	7/8"	58	54.0	39.0	500
IMO86130	15/16"	58	54.0	40.5	510
IMO86132	1"	60	54.0	42.5	520
IMO86134	1-1/16"	60	54.0	45.0	540
IMO86136	1-1/8"	62	54.0	46.0	660
IMO86138	1-3/16"	62	54.0	49.0	680
IMO86140	1-1/4"	63	54.0	51.5	690
IMO86142	1-5/16"	63	54.0	54.0	710
IMO86144	1-3/8"	66	54.0	55.0	720
IMO86146	1-7/16"	66	54.0	56.5	750
IMO86148	1-1/2"	66	54.0	59.0	800
IMO86150	1-9/16"	66	54.0	61.0	800
IMO86152	1-5/8"	68	54.0	62.5	830
IMO86154	1-11/16"	70	54.0	65.0	910
IMO86156	1-3/4"	70	60.3	67.5	1100
IMO86158	1-13/16"	72	60.3	69.0	1130
IMO86160	1-7/8"	72	60.3	70.0	1250
IMO86162	1-15/16"	76	60.3	72.5	1370
IMO86164	2"	77	60.3	74.0	1400
IMO86166	2-1/16"	80	60.3	76.5	1450
IMO86168	2-1/8"	80	60.3	79.0	1460
IMO86170	2-3/16"	84	60.3	80.0	1630
IMO86172	2-1/4"	84	60.3	82.5	1700
IMO86174	2-5/16"	84	60.3	84.0	1780
IMO86176	2-3/8"	88	60.3	86.5	1830
IMO86178	2-7/16"	88	60.3	89.0	2050
IMO86180	2-1/2"	88	60.3	91.5	2080
IMO86182	2-9/16"	88	60.3	92.5	2100
IMO86184	2-5/8"	88	60.3	95.0	2200
IMO86186	2-11/16"	96	60.3	96.5	2350
IMO86188	2-3/4"	96	60.3	99.0	2440
IMO86190	2-13/16"	96	60.3	101.5	2680
IMO86192	2-7/8"	96	60.3	102.5	2750
IMO86194	2-15/16"	100	60.3	104.5	2750
IMO86196	3"	100	60.3	106.5	2860
IMO86198	3-1/16"	100	60.3	109.0	2880
IMO861100	3-1/8"	100	60.3	111.5	2890
IMO861104	3-1/4"	100	60.3	115.0	3300
IMO861108	3-3/8"	106	60.3	119.0	3500
IMO861112	3-1/2"	108	60.3	124.0	3830
IMO861116	3-5/8"	110	86.0	126.0	4920
IMO861120	3-3/4"	110	86.0	130.0	5160
IMO861124	3-7/8"	110	86.0	133.5	5580
IMO861128	4"	120	95.0	137.5	5880
IMO861132	4-1/8"	120	95.0	142.0	6620
IMO861136	4-1/4"	120	95.0	146.0	6860
IMO861144	4-1/2"	120	95.0	153.0	7220

Item No.	S	L(mm)	D1(mm)	D2(mm)	G
IMO86219	19	58	54	35.0	500
IMO86220	20	58	54	36.0	500
IMO86221	21	58	54	37.5	500
IMO86222	22	58	54	39.0	500
IMO86223	23	58	54	40.0	510
IMO86224	24	58	54	41.5	510
IMO86225	25	60	54	42.5	520
IMO86226	26	60	54	44.0	540
IMO86227	27	60	54	45.0	540
IMO86228	28	60	54	46.5	560
IMO86229	29	60	54	45.0	660
IMO86230	30	62	54	49.0	680
IMO86231	31	62	54	50.0	680
IMO86232	32	62	54	51.5	690
IMO86233	33	62	54	52.5	690
IMO86234	34	62	54	54.0	710
IMO86235	35	66	54	55.0	720
IMO86236	36	66	54	56.5	750
IMO86237	37	66	54	58.0	780
IMO86238	38	66	54	59.0	800
IMO86239	39	66	54	60.0	800
IMO86240	40	66	54	61.0	800
IMO86241	41	68	54	62.5	830
IMO86242	42	70	54	65.0	900
IMO86243	43	70	54	65.0	910
IMO86244	44	70	54	66.0	920
IMO86246	46	72	54	69.0	1080
IMO86247	47	72	60.3	70.0	1140
IMO86248	48	76	54	71.5	1200
IMO86250	50	76	54	74.0	1240
IMO86252	52	80	54	76.5	1300
IMO86254	54	80	54	79.0	1550
IMO86255	55	84	54	80.0	1600
IMO86256	56	84	84	81.0	1675
IMO86258	58	84	54	84.0	1750
IMO86260	60	88	54	86.5	1780
IMO86263	63	88	54	90.0	1950
IMO86265	65	92	54	92.5	2000
IMO86267	67	92	54	95.0	2200
IMO86270	70	96	54	99.0	2300
IMO86271	71	96	60	100.0	2460
IMO86275	75	102	60	105.0	2830
IMO86277	77	102	60	108.0	2860
IMO86280	80	102	60	111.5	2890
IMO86285	85	106	60	117.5	3380
IMO86290	90	108	60	124.0	3730
IMO86295	95	108	86	128.0	4642
IMO862100	100	120	95	136.0	5899
IMO862105	105	120	95	142.0	6275

# EURO STYLE 1"DR. DEEP IMPACT SOCKET

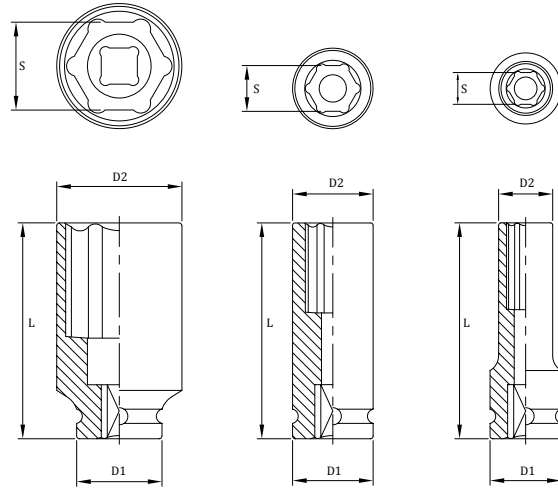

Socket & Wrench

Impact Socket

Air Chisels

Automotive Tools

Item No.	S	L(mm)	D1(mm)	D2(mm)	G
ILMO86124	3/4"	108	54.0	35.0	970
ILMO86126	13/16"	108	54.0	37.5	980
ILMO86128	7/8"	108	54.0	39.0	1000
ILMO86130	15/16"	108	54.0	41.5	1020
ILMO86132	1"	108	54.0	42.7	1060
ILMO86134	1-1/16"	108	54.0	44.7	1120
ILMO86136	1-1/8"	108	54.0	46.0	1180
ILMO86138	1-3/16"	108	54.0	49.0	1200
ILMO86140	1-1/4"	108	54.0	51.5	1220
ILMO86142	1-5/16"	108	54.0	54.0	1240
ILMO86144	1-3/8"	108	54.0	55.0	1260
ILMO86146	1-7/16"	108	54.0	56.5	1280
ILMO86148	1-1/2"	108	54.0	59.0	1330
ILMO86150	1-9/16"	108	54.0	61.0	1400
ILMO86152	1-5/8"	108	54.0	62.5	1470
ILMO86154	1-11/16"	108	54.0	65.0	1530
ILMO86156	1-3/4"	108	60.3	67.5	1600
ILMO86158	1-13/16"	108	60.3	69.0	1640
ILMO86160	1-7/8"	108	60.3	70.0	1680
ILMO86162	1-15/16"	108	60.3	72.5	1730
ILMO86164	2"	108	60.3	74.0	1780
ILMO86166	2-1/16"	108	60.3	76.5	1870
ILMO86168	2-1/8"	108	60.3	79.0	1910
ILMO86170	2-3/16"	108	60.3	80.0	1950
ILMO86172	2-1/4"	108	60.3	82.5	2010
ILMO86174	2-5/16"	108	60.3	84.0	2080
ILMO86176	2-3/8"	108	60.3	86.5	2140
ILMO86178	2-7/16"	120	60.3	89.0	2240
ILMO86180	2-1/2"	120	60.3	91.5	2350
ILMO86182	2-9/16"	120	60.3	92.5	2400
ILMO86184	2-5/8"	120	60.3	95.0	2470
ILMO86186	2-11/16"	125	60.3	96.5	2500
ILMO86188	2-3/4"	125	60.3	99.0	2540
ILMO86190	2-13/16"	130	60.3	101.5	2590
ILMO86192	2-7/8"	130	60.3	102.5	2630
ILMO86194	2-15/16"	135	60.3	104.5	2790
ILMO86196	3"	135	60.3	106.5	2850
ILMO86198	3-1/16"	135	60.3	109.0	3120
ILMO861100	3-1/8"	135	60.3	111.5	3200

Item No.	S	L(mm)	D1(mm)	D2(mm)	G
ILMO86219	19	108	54	35.0	970
ILMO86220	20	108	54	36.0	970
ILMO86221	21	108	54	37.5	920
ILMO86222	22	108	54	39.0	1000
ILMO86223	23	108	54	40.0	1010
ILMO86224	24	108	54	41.5	1020
ILMO86225	25	108	54	42.5	1060
ILMO86226	26	108	54	44.0	1100
ILMO86227	27	108	54	45.0	1120
ILMO86228	28	108	54	46.5	1140
ILMO86229	29	108	54	47.5	1180
ILMO86230	30	108	54	49.0	1200
ILMO86232	32	108	54	51.5	1220
ILMO86233	33	108	54	52.5	1230
ILMO86234	34	108	54	54.0	1240
ILMO86235	35	108	54	55.0	1260
ILMO86236	36	108	54	56.5	1280
ILMO86238	38	108	54	59.0	1330
ILMO86240	40	108	54	61.0	1400
ILMO86241	41	108	54	62.5	1470
ILMO86242	42	108	54	64.0	1520
ILMO86243	43	108	54	65.0	1550
ILMO86244	44	108	54	66.0	1580
ILMO86246	46	108	54	69.0	1640
ILMO86248	48	108	58	72.0	1700
ILMO86250	50	108	58	74.0	1780
ILMO86252	52	108	58	77.0	1845
ILMO86254	54	108	58	79.0	1910
ILMO86255	55	108	54	80.0	1950
ILMO86256	56	108	62	81.0	1985
ILMO86257	57	108	62	82.5	2020
ILMO86258	58	108	62	84.0	2080
ILMO86260	60	108	62	86.5	2140
ILMO86262	62	120	62	89.0	2210
ILMO86263	63	120	62	90.0	2280
ILMO86265	65	120	62	92.5	2400
ILMO86267	67	124	62	95.0	2470
ILMO86270	70	124	62	99.0	2540
ILMO86275	75	124	86	105.0	2790
ILMO86280	80	135	86	112.0	3200
ILMO86285	85	140	86	115.0	3700
ILMO86290	90	140	86	123.0	4200



# IMPACT SOCKET

## 1-1/2"DR. IMPACT SOCKET

### 1-1/2"DR. IMPACT SOCKET

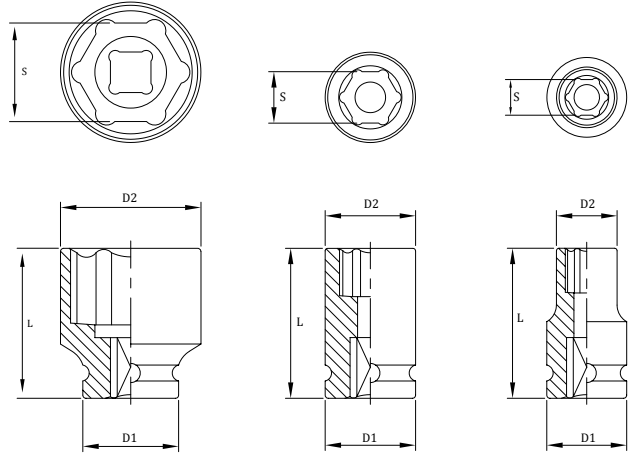

Item No.	S	L(mm)	D1(mm)	D2(mm)	G
IMO1261030	15/16"	75.0	86.0	60.0	1700
IMO1261044	1-3/8"	78.0	86.1	62.0	1800
IMO1261046	1-7/16"	78.0	86.1	64.0	1850
IMO1261048	1-1/2"	78.0	86.1	66.0	1900
IMO1261050	1-9/16"	78.0	86.1	68.1	2000
IMO1261052	1-5/8"	80.0	86.1	70.1	2100
IMO1261054	1-11/16"	80.0	86.1	71.1	2100
IMO1261056	1-3/4"	84.1	86.1	74.9	2150
IMO1261058	1-13/16"	84.1	86.1	75.9	2200
IMO1261060	1-7/8"	84.1	86.1	78.0	2250
IMO1261062	1-15/16"	87.1	86.1	80.0	2250
IMO1261064	2"	87.1	86.1	82.0	2300
IMO1261066	2-1/16"	87.1	86.1	83.1	2300
IMO1261068	2-1/8"	89.9	86.1	86.1	2350
IMO1261070	2-3/16"	89.9	86.1	86.1	2500
IMO1261072	2-1/4"	91.9	86.1	86.1	2600
IMO1261074	2-5/16"	91.9	86.1	91.9	2650
IMO1261076	2-3/8"	91.9	86.1	93.0	2700
IMO1261078	2-7/16"	95.0	86.1	96.0	2900
IMO1261080	2-1/2"	95.0	86.1	97.0	3000
IMO1261082	2-9/16"	95.0	86.1	97.0	3050
IMO1261084	2-5/8"	100.0	86.1	103.1	3250
IMO1261086	2-11/16"	100.0	86.1	103.9	3350
IMO1261088	2-3/4"	100.0	86.1	104.9	3400
IMO1261090	2-13/16"	103.1	86.1	108.0	3700
IMO1261092	2-7/8"	103.1	86.1	108.0	3750
IMO1261094	2-15/16"	103.1	86.1	110.0	3800
IMO1261096	3"	103.1	86.1	110.0	4000
IMO1261098	3-1/16"	103.1	86.1	115.1	4050
IMO1261100	3-1/8"	110.0	86.1	116.1	4300
IMO1261102	3-3/16"	110.0	86.1	125.0	4300
IMO1261104	3-1/4"	110.0	86.1	125.0	4300
IMO1261106	3-5/16"	110.0	86.1	125.0	4600
IMO1261108	3-3/8"	118.1	86.1	125.0	4650
IMO1261110	3-7/16"	118.1	86.1	128.0	4900
IMO1261112	3-1/2"	118.1	86.1	130.0	5000
IMO1261114	3-9/16"	118.1	86.1	130.0	5050
IMO1261116	3-5/8"	118.1	86.1	130.0	5200
IMO1261118	3-11/16"	118.1	86.1	130.0	5250
IMO1261120	3-3/4"	118.1	95.0	136.9	7350
IMO1261122	3-13/16"	125.0	95.0	140.0	7550
IMO1261124	3-7/8"	125.0	95.0	140.0	7750
IMO1261126	3-15/16"	125.0	95.0	140.0	7800
IMO1261128	4"	125.0	95.0	140.0	8250
IMO1261130	4-1/16"	125.0	95.0	146.1	8450
IMO1261132	4-1/8"	125.0	95.0	150.1	8500
IMO1261134	4-3/16"	125.0	95.0	150.1	8700
IMO1261136	4-1/4"	125.0	95.0	150.1	9150
IMO1261138	4-5/16"	125.0	95.0	156.0	9250
IMO1261140	4-3/8"	125.0	95.0	160.0	9450
IMO1261142	4-7/16"	125.0	95.0	160.0	9550
IMO1261144	4-1/2"	135.1	95.0	160.0	9900
IMO1261146	4-5/8"	135.1	95.0	165.1	10600
IMO1261152	4-3/4"	135.1	95.0	167.9	10900
IMO1261156	4-7/8"	134.9	127.0	175.0	11600
IMO1261160	5"	140.0	127.0	179.1	12300
IMO1261164	5-1/8"	140.0	127.0	184.9	12700
IMO1261168	5-1/4"	145.0	127.0	188.0	13600
IMO1261172	5-3/8"	150.1	127.0	195.1	14000
IMO1261176	5-1/2"	160.0	127.0	198.1	14900
IMO1261192	6"	165.1	127.0	209.0	17900
IMO1261208	6-1/2"	175.0	127.0	225.8	22000

Item No.	S	L(mm)	D1(mm)	D2(mm)
IMO1262032	32	75	86	60
IMO1262033	33	75	86	60
IMO1262034	34	75	86	60
IMO1262035	35	75	86	60
IMO1262036	36	80	86	64
IMO1262037	37	80	86	64
IMO1262038	38	80	86	64
IMO1262039	39	80	86	70
IMO1262040	40	80	86	70
IMO1262041	41	80	86	70
IMO1262042	42	80	86	70
IMO1262043	43	80	86	75
IMO1262044	44	80	86	75
IMO1262045	45	80	86	75
IMO1262046	46	84	86	76
IMO1262047	47	80	86	75
IMO1262048	48	82	86	80
IMO1262049	49	82	86	80
IMO1262050	50	87	86	81
IMO1262051	51	82	86	80
IMO1262052	52	82	86	80
IMO1262054	54	89	86	86
IMO1262056	56	92	86	86
IMO1262055	55	90	86	86
IMO1262057	57	92	86	86
IMO1262058	58	92	86	92
IMO1262059	59	92	86	92
IMO1262060	60	92	86	93
IMO1262061	61	96	86	96
IMO1262062	62	96	86	96
IMO1262065	65	95	86	97
IMO1262067	67	101	86	100
IMO1262070	70	100	86	105
IMO1262073	73	105	86	109
IMO1262075	75	103	86	110
IMO1262076	76	110	86	115
IMO1262077	77	110	86	115
IMO1262080	80	110	86	116
IMO1262085	85	118	86	125
IMO1262086	86	116	86	127
IMO1262090	90	118	86	130
IMO1262095	95	118	95	137
IMO1262100	100	125	95	140
IMO1262105	105	125	95	150
IMO1262110	110	125	95	156
IMO1262115	115	135	95	160
IMO1262130	130	140	127	185

# 1-1/2"DR. DEEP IMPACT SOCKET

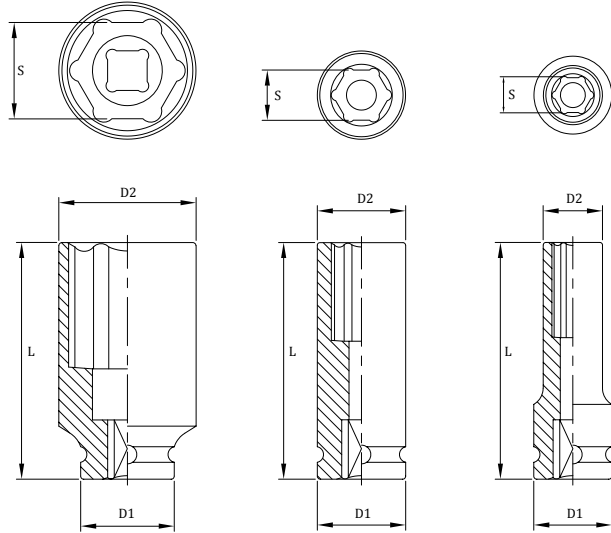

Item No.	S	L(mm)	D1(mm)	D2(mm)	G
ILMO1261048	1-1/2"	115.1	86.1	68.1	2750
ILMO1261052	1-5/8"	115.1	86.1	72.1	2850
ILMO1261056	1-3/4"	115.1	86.1	74.9	2950
ILMO1261060	1-7/8"	115.1	86.1	80.0	3250
ILMO1261064	2"	135.1	86.1	83.1	3650
ILMO1261068	2-1/8"	140.0	86.1	86.1	3800
ILMO1261070	2-3/16"	140.0	86.1	88.1	4200
ILMO1261072	2-1/4"	142.0	86.1	89.9	4300
ILMO1261074	2-5/16"	150.1	86.1	91.9	4400
ILMO1261076	2-3/8"	150.1	86.1	94.0	4600
ILMO1261078	2-7/16"	150.1	86.1	96.0	4700
ILMO1261080	2-1/2"	150.1	86.1	98.0	4850
ILMO1261082	2-9/16"	150.1	86.1	100.1	4950
ILMO1261084	2-5/8"	150.1	86.1	102.1	5050
ILMO1261088	2-3/4"	160.0	86.1	105.9	5350
ILMO1261092	2-7/8"	160.0	86.1	109.0	6050
ILMO1261094	2-15/16"	169.9	86.1	112.0	6200
ILMO1261096	3"	169.9	86.1	114.0	6850
ILMO1261098	3-1/16"	169.9	86.1	116.1	7000
ILMO1261100	3-1/8"	169.9	86.1	118.1	7050
ILMO1261104	3-1/4"	169.9	86.1	125.0	7400
ILMO1261106	3-5/16"	169.9	86.1	125.0	7650
ILMO1261108	3-3/8"	169.9	86.1	125.0	7800
ILMO1261112	3-1/2"	169.9	86.1	130.0	8100
ILMO1261116	3-5/8"	169.9	86.1	130.0	9100
ILMO1261120	3-3/4"	180.1	95.0	136.9	11550
ILMO1261128	4"	190.0	95.0	140.0	13100
ILMO1261132	4-1/8"	190.0	95.0	150.1	12700
ILMO1261136	4-1/4"	190.0	95.0	150.1	14050
ILMO1261144	4-1/2"	210.1	95.0	160.0	15800
ILMO1261148	4-5/8"	210.1	95.0	167.9	16550
ILMO1261152	4-3/4"	210.1	95.0	167.9	17900

Item No.	S	L(mm)	D1(mm)	D2(mm)	G
ILMO1262041	41	115	86	70	2850
ILMO1262046	46	115	86	76	3200
ILMO1262050	50	135	86	81	3600
ILMO1262055	55	140	86	86	4200
ILMO1262060	60	150	86	93	4600
ILMO1262065	65	150	86	97	4950
ILMO1262070	70	160	86	105	5350
ILMO1262075	75	170	86	110	6200
ILMO1262080	80	170	86	116	7050
ILMO1262085	85	170	86	125	7700
ILMO1262090	90	170	86	130	8750
ILMO1262095	95	180	95	137	11550
ILMO1262100	100	190	95	140	12800
ILMO1262105	105	190	95	150	13700
ILMO1262110	110	190	95	156	14900
ILMO1262115	115	210	95	160	15800

Socket & Wrench

Impact Socket

Air Chisels

Automotive Tools

# IMPACT SOCKET

## 2-1/2"DR. IMPACT SOCKET

### 2-1/2"DR. IMPACT SOCKET



2-1/2"

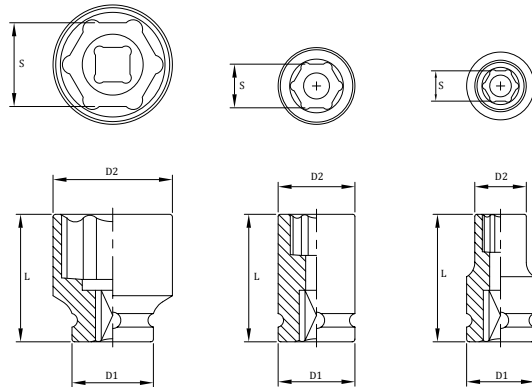
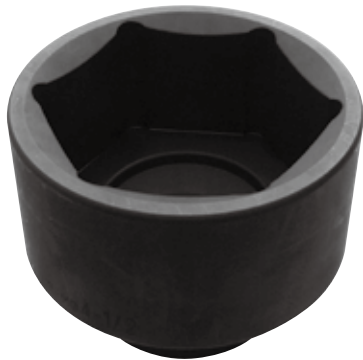

Item No.	S	L(mm)	D1(mm)	D2(mm)	G
IMO2061076	2-3/8"	115.0	127.0	104.0	6800
IMO2061078	2-7/16"	115.0	127.0	104.0	6800
IMO2061080	2-1/2"	115.0	127.0	104.0	6850
IMO2061082	2-9/16"	115.0	127.0	104.0	6850
IMO2061084	2-5/8"	115.0	127.0	104.0	6900
IMO2061086	2-11/16"	115.0	127.0	104.0	6900
IMO2061088	2-3/4"	115.0	127.0	104.0	6900
IMO2061090	2-13/16"	125.0	127.0	115.0	7000
IMO2061092	2-7/8"	125.0	127.0	115.0	7000
IMO2061094	2-15/16"	125.0	127.0	115.0	7000
IMO2061096	3"	140.0	127.0	119.9	7100
IMO2061100	3-1/8"	140.0	127.0	124.0	7200
IMO2061104	3-1/4"	140.0	127.0	127.0	7200
IMO2061108	3-3/8"	140.0	127.0	131.1	7950
IMO2061112	3-1/2"	140.0	127.0	135.1	8150
IMO2061116	3-5/8"	145.0	127.0	138.9	8400
IMO2061120	3-3/4"	145.0	127.0	143.0	8950
IMO2061124	3-7/8"	150.1	127.0	147.1	9100
IMO2061128	4"	150.1	127.0	151.1	9800
IMO2061132	4-1/8"	154.9	127.0	154.9	10450
IMO2061136	4-1/4"	160.0	127.0	159.0	11200
IMO2061140	4-3/8"	165.1	127.0	163.1	11500
IMO2061144	4-1/2"	165.1	127.0	167.1	12200
IMO2061148	4-5/8"	169.9	127.0	172.0	12600
IMO2061152	4-3/4"	169.9	127.0	176.0	12900
IMO2061156	4-7/8"	175.0	127.0	181.1	18900
IMO2061160	5"	175.0	127.0	184.9	19350
IMO2061164	5-1/8"	175.0	127.0	188.0	20000
IMO2061168	5-1/4"	175.0	127.0	193.0	20500
IMO2061172	5-3/8"	180.1	127.0	197.1	21500
IMO2061176	5-1/2"	180.1	127.0	201.9	22800
IMO2061180	5-5/8"	184.9	127.0	206.0	23300
IMO2061184	5-3/4"	184.9	127.0	210.1	24300
IMO2061188	5-7/8"	184.9	127.0	214.1	25600
IMO2061192	6"	184.9	127.0	217.9	26100
IMO2061196	6-1/8"	190.0	127.0	223.0	27200
IMO2061200	6-1/4"	190.0	127.0	227.1	28200
IMO2061204	6-3/8"	195.1	127.0	230.9	29400
IMO2061208	6-1/2"	195.1	127.0	235.0	30800
IMO2061212	6-5/8"	195.1	127.0	240.0	31300
IMO2061216	6-3/4"	195.1	127.0	244.1	33000
IMO2061220	6-7/8"	199.9	127.0	247.9	33800
IMO2061224	7"	199.9	127.0	252.0	34100
IMO2061240	7-1/2"	210.1	151.9	264.9	39000
IMO2061244	7-5/8"	210.1	151.9	268.0	39900
IMO2061256	8"	220.0	151.9	278.1	43000
IMO2061260	8-1/8"	232.0	175.0	280.0	45000
IMO2061264	8-1/4"	232.0	175.0	280.0	47300
IMO2061268	8-3/8"	239.0	175.0	290.0	48200
IMO2061272	8-1/2"	250.0	175.0	290.0	50600
IMO2061280	8-3/4"	253.0	175.0	300.0	53400
IMO2061284	8-7/8"	258.0	175.0	300.0	55800
IMO2061288	9"	258.0	175.0	310.0	57000
IMO2061292	9-1/8"	258.0	175.0	310.0	59600
IMO2061296	9-1/4"	275.0	175.0	310.0	61700

Item No.	S	L(mm)	D1(mm)	D2(mm)	G
IMO2062060	60	115	127	104	6800
IMO2062065	65	115	127	104	6850
IMO2062070	70	115	127	104	6900
IMO2062075	75	125	127	115	7000
IMO2062080	80	140	127	124	7200
IMO2062085	85	140	127	130	7900
IMO2062090	90	145	127	136	8200
IMO2062095	95	145	127	143	8950
IMO2062100	100	150	127	149	9700
IMO2062105	105	155	127	155	10450
IMO2062110	110	160	127	161	11300
IMO2062115	115	165	127	167	12200
IMO2062120	120	158	127	170	12900
IMO2062125	125	158	127	170	19000
IMO2062130	130	175	127	188	20000
IMO2062135	135	174	127	190	21400
IMO2062140	140	176	127	190	22800
IMO2062145	145	185	127	208	24200
IMO2062150	150	190	210	210	25600
IMO2062155	155	190	210	210	27000
IMO2062160	160	194	220	220	29100
IMO2062165	165	201	230	230	30800
IMO2062170	170	201	230	230	32400
IMO2062175	175	208	240	240	33800
IMO2062180	180	214	240	240	35600
IMO2062185	185	214	250	250	38000
IMO2062190	190	218	260	260	39000
IMO2062200	200	226	270	270	42600
IMO2062210	210	232	280	280	47300

# 3-1/2"DR. IMPACT SOCKET

## 3-1/2"DR. IMPACT SOCKET

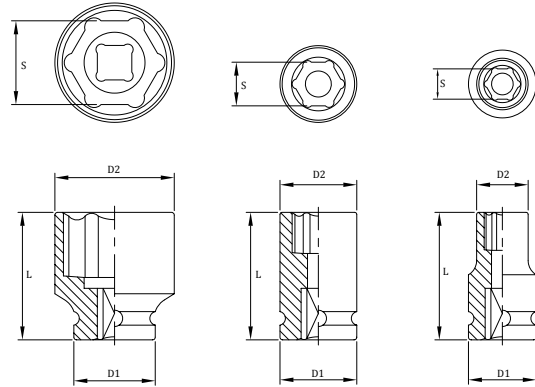

Socket & Wrench

Impact Socket

Air Chisels

Automotive Tools

Item No.	S	L(mm)	D1(mm)	D2(mm)	G
IMO2861132	4-1/8"	175	175	165	18400
IMO2861134	4-3/16"	175	175	174	18500
IMO2861138	4-5/16"	175	175	174	18650
IMO2861140	4-3/8"	175	175	174	18850
IMO2861142	4-7/16"	175	175	174	18900
IMO2861148	4-5/8"	175	175	182	19700
IMO2861152	4-3/4"	175	175	182	20800
IMO2861156	4-7/8"	175	175	182	21000
IMO2861160	5"	190	175	190	22000
IMO2861164	5-1/8"	190	175	198	23100
IMO2861166	5-3/16"	190	175	198	23200
IMO2861168	5-1/4"	190	175	198	23500
IMO2861172	5-3/8"	200	175	198	24600
IMO2861176	5-1/2"	200	175	205	25650
IMO2861180	5-5/8"	210	175	212	26300
IMO2861184	5-3/4"	210	175	212	32100
IMO2861188	5-7/8"	210	175	212	32600
IMO2861192	6"	220	175	214	33400
IMO2861196	6-1/8"	220	175	214	34650
IMO2861200	6-1/4"	220	175	218	35400
IMO2861204	6-3/8"	230	175	218	37000
IMO2861208	6-1/2"	230	175	230	38700
IMO2861212	6-5/8"	240	175	230	39500
IMO2861216	6-3/4"	240	175	230	40000
IMO2861220	6-7/8"	250	175	230	41800
IMO2861224	7"	250	175	237	42600
IMO2861228	7-1/8"	250	175	237	43450
IMO2861232	7-1/4"	260	175	237	45100
IMO2861236	7-3/8"	260	175	242	46200
IMO2861240	7-1/2"	260	175	242	48450
IMO2861244	7-5/8"	270	175	246	49000
IMO2861248	7-3/4"	270	175	249	49800
IMO2861250	7-13/16"	280	175	249	50400
IMO2861252	7-7/8"	280	175	249	52000
IMO2861256	8"	280	175	256	52850
IMO2861260	8-1/8"	290	175	256	55200
IMO2861264	8-1/4"	290	175	256	57000
IMO2861268	8-3/8"	290	175	263	58000
IMO2861272	8-1/2"	300	175	267	60500
IMO2861280	8-3/4"	300	175	270	64000
IMO2861284	8-7/8"	310	175	273	65000
IMO2861288	9"	310	175	276	65700
IMO2861292	9-1/8"	320	175	279	68400
IMO2861296	9-1/4"	320	175	285	70800
IMO2861328	10-1/4"	340	175	330	71800

Item No.	S	L(mm)	D1(mm)	D2(mm)	G
IMO2862105	105	165	175	175	18400
IMO2862110	110	174	175	175	18650
IMO2862115	115	174	175	175	19400
IMO2862120	120	182	175	175	20800
IMO2862125	125	182	175	175	21900
IMO2862130	130	198	175	190	23100
IMO2862135	135	198	175	190	24300
IMO2862140	140	205	175	200	25650
IMO2862145	145	212	175	210	31500
IMO2862150	150	212	175	210	32600
IMO2862155	155	214	175	220	34200
IMO2862160	160	218	175	220	36700
IMO2862165	165	230	175	230	38700
IMO2862170	170	230	175	240	39750
IMO2862175	175	230	175	250	41800
IMO2862180	180	237	175	250	42900
IMO2862185	185	237	175	260	45100
IMO2862190	190	242	175	260	48450
IMO2862195	195	246	175	270	49500
IMO2862200	200	249	175	280	52000
IMO2862210	210	256	175	290	57000
IMO2862215	215	263	175	300	59800
IMO2862225	225	273	175	310	65000
IMO2862230	230	276	175	310	68000
IMO2862235	235	279	175	320	70800

# 12 POINT IMPACT SOCKET

## 12 POINT IMPACT SOCKET

### EURO STYLE 1/2"DR. 12 POINT IMPACT SOCKET



1/2"

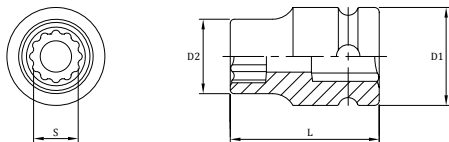

Item No.	S	L (mm)	D1 (mm)	D2 (mm)	G
IMO47208	8	38	22	14.5	50
IMO47209	9	38	22	15.6	50
IMO47210	10	38	22	16.7	65
IMO47211	11	38	22	18.0	65
IMO47212	12	38	22	19.0	65
IMO47213	13	38	24	20.2	80
IMO47214	14	38	24	21.5	80
IMO47215	15	38	25	23.0	87
IMO47216	16	38	25	25.0	87
IMO47217	17	38	26	26.0	95
IMO47218	18	38	27	27.0	102
IMO47219	19	38	28	28.0	105
IMO47220	20	38	30	30.0	125
IMO47221	21	38	30	30.0	125
IMO47222	22	38	32	32.0	144
IMO47223	23	38	33	33.0	154
IMO47224	24	38	34	34.0	160
IMO47225	25	42	36	36.0	201
IMO47226	26	42	36	36.0	195
IMO47227	27	42	38	38.0	224
IMO47228	28	42	40	40.0	252
IMO47229	29	42	41	41.0	265
IMO47230	30	42	38	42.0	253
IMO47231	31	42	38	44.0	260
IMO47232	32	42	38	44.0	260

### EURO STYLE 1/2"DR. 12 POINT DEEP IMPACT SOCKET



1/2"

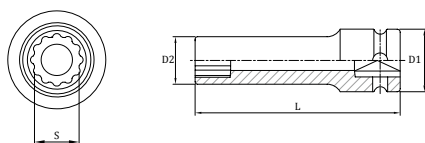

Item No.	S	L (mm)	D1 (mm)	D2 (mm)	G
ILMO47208	8	82	14.5	25.0	114
ILMO47209	9	82	15.6	25.0	120
ILMO47210	10	82	16.7	25.0	128
ILMO47211	11	82	18.0	25.0	132
ILMO47212	12	82	19.0	25.0	140
ILMO47213	13	82	20.2	25.0	149
ILMO47214	14	82	21.5	25.0	153
ILMO47215	15	82	23.0	25.0	169
ILMO47216	16	82	24.0	25.0	167
ILMO47217	17	82	26.0	25.0	200
ILMO47218	18	82	27.0	25.0	208
ILMO47219	19	82	28.0	25.0	225
ILMO47220	20	82	29.0	25.0	235
ILMO47221	21	82	30.0	25.0	243
ILMO47222	22	82	32.0	30.0	290
ILMO47223	23	82	33.0	30.0	291
ILMO47224	24	82	34.0	30.0	314
ILMO47225	25	82	36.0	30.0	351
ILMO47226	26	82	36.0	30.0	360
ILMO47227	27	82	38.0	30.0	374
ILMO47228	28	82	40.0	30.0	400
ILMO47229	29	82	41.0	30.0	425
ILMO47230	30	82	42.0	30.0	432
ILMO47231	31	82	43.0	30.0	440
ILMO47232	32	82	44.0	30.0	450
ILMO47233	33	82	46.0	35.0	471
ILMO47234	34	82	48.0	35.0	528
ILMO47235	35	82	49.0	35.0	532
ILMO47236	36	82	50.0	35.0	548
ILMO47238	38	82	52.0	35.0	552
ILMO47241	41	82	56.0	35.0	629

## 12 POINT IMPACT SOCKET SET

### 27PC 1/2" DR. 12 POINT IMPACT SOCKET SET



1/2"



Item No.	27PC-25MO
Holder in box	L:500 x W:190 x L:70 mm
WEIGHT	5 (kg)

CONTENT	
1/2" DR. 12PT IMPACT SOCKET	10, 11, 12, 13, 14, 15, 16, 17, 18, 19, 20, 21, 22, 23, 24, 25, 26, 27, 28, 29, 30, 31, 32, 33, 34, 35, 36

### 27PC 1/2" DR. 12 POINT DEEP IMPACT SOCKET SET



1/2"



Item No.	27PC-25LMO
Holder in box	L:500 x W:190 x L:110 mm
WEIGHT	9.2 (kg)

CONTENT	
1/2" DR. 12PT DEEP IMPACT SOCKET	10, 11, 12, 13, 14, 15, 16, 17, 18, 19, 20, 21, 22, 23, 24, 25, 26, 27, 28, 29, 30, 31, 32, 33, 34, 35, 36

### 12PC 1/2"DR. 12 POINT IMPACT SOCKET SET



1/2"



Item No.	12PC-44M-12PT
BLOW CASE	L:366 x W:162 x H:88 mm
WEIGHT	3425 (g)

CONTENT	
1/2"DR. 12-POINT IMPACT SOCKET	23, 24, 25, 26, 27, 28, 30, 32, 33, 34, 35, 36

### 12PC 1/2"DR. 12 POINT DEEP IMPACT SOCKET SET



1/2"



Item No.	12PC-44LM-12PT
BLOW CASE	L:355 x W:270 x H:76 mm
WEIGHT	5067 (g)

CONTENT	
1/2"DR. 12-POINT DEEP IMPACT SOCKET	23, 24, 25, 26, 27, 28, 30, 32, 33, 34, 35, 36

Socket & Wrench

Impact Socket

Air Chisels

Automotive Tools

# STUBBY IMPACT SOCKET

## 3/8"DR. STUBBY IMPACT SOCKETS

### 3/8"DR. HEX SHAPE STUBBY IMPACT SOCKET



3/8"

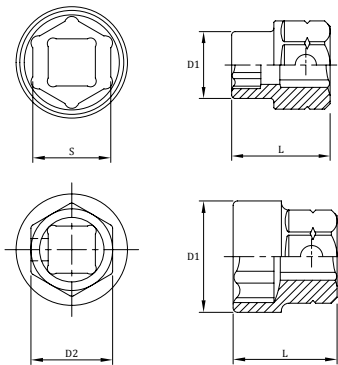

6	S	L(mm)	D1(mm)	D2(mm)
ISHMO36206	6	22.5	10.2	17
ISHMO36207	7	22.5	11.4	17
ISHMO36208	8	22.5	12.7	17
ISHMO36209	9	22.5	14.0	17
ISHMO36210	10	22.5	15.2	17
ISHMO36211	11	22.5	17.0	17
ISHMO36212	12	22.5	18.0	17
ISHMO36213	13	22.5	20.0	17
ISHMO36214	14	22.5	21.5	17
ISHMO36215	15	22.5	22.0	17
ISHMO36216	16	22.5	23.5	17
ISHMO36217	17	22.5	24.0	17
ISHMO36218	18	22.5	25.0	17
ISHMO36219	19	22.5	26.0	17

6	S	L(mm)	D1(mm)	D2(mm)
ISHMO36108	1/4"	22.5	10.6	17
ISHMO36109	9/32"	22.5	11.8	17
ISHMO36110	5/16"	22.5	12.6	17
ISHMO36112	3/8"	22.5	14.6	17
ISHMO36114	7/16"	22.5	17.1	17
ISHMO36116	1/2"	22.5	20.0	17
ISHMO36118	9/16"	22.5	21.0	17
ISHMO36120	5/8"	22.5	23.5	17
ISHMO36122	11/16"	22.5	24.0	17
ISHMO36124	3/4"	22.5	26.0	17

# 1/2"DR. HEX SHAPE STUBBY IMPACT SOCKET



1/2"

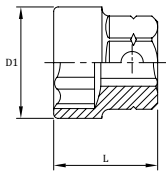
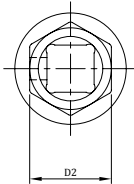
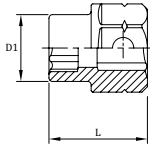
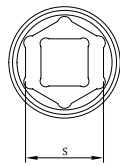

6	S	L(mm)	D1(mm)	D2(mm)
ISHMO46208	8	28	14.5	22
ISHMO46209	9	28	15.6	22
ISHMO46210	10	28	16.7	22
ISHMO46211	11	28	18.0	22
ISHMO46212	12	28	19.0	22
ISHMO46213	13	28	20.2	22
ISHMO46214	14	28	21.5	22
ISHMO46215	15	28	23.0	22
ISHMO46216	16	28	24.5	22
ISHMO46217	17	28	26.0	22
ISHMO46218	18	28	27.0	22
ISHMO46219	19	28	28.0	22
ISHMO46220	20	28	30.0	22
ISHMO46221	21	28	30.0	22
ISHMO46222	22	28	32.0	22
ISHMO46223	23	28	34.0	22
ISHMO46224	24	28	34.0	22
ISHMO46227	27	30	38.0	22
ISHMO46230	30	30	42.0	22
ISHMO46232	32	30	44.0	22

6	S	L(mm)	D1(mm)	D2(mm)
ISHMO46112	3/8"	28	16.0	22
ISHMO46114	7/16"	28	18.0	22
ISHMO46116	1/2"	28	20.0	22
ISHMO46118	9/16"	28	21.8	22
ISHMO46120	5/8"	28	24.0	22
ISHMO46122	11/16"	28	26.0	22
ISHMO46124	3/4"	28	28.0	22
ISHMO46126	13/16"	28	30.0	22
ISHMO46128	7/8"	28	32.0	22
ISHMO46130	15/16"	28	34.0	22
ISHMO46132	1"	28	36.0	22

Socket & Wrench

Impact Socket

Air Chisels

Automotive Tools



# STUBBY IMPACT SOCKET

## 10PC 3/8"DR. STUBBY IMPACT SOCKET SET (HEX SHANK) (mm)



3/8"



Item No.	10PC-SH35
HOLDER IN BOX	L: 305 mm
WEIGHT	700 (g)

CONTENT	
3/8"DR. 6PT STUBBY IMPACT SOCKETS W/ HEX SHANK:(L:22.5mm)	1/4", 9/32", 5/16", 3/8", 7/16", 1/2", 9/16", 5/8", 11/16", 3/4"

## 14PC 3/8"DR. STUBBY IMPACT SOCKET SET (HEX SHANK) (SAE)



3/8"

Item No.	14PC-SH3M
HOLDER IN BOX	L: 305 mm
WEIGHT	1.5 (kg)

CONTENT	
3/8"DR. 6PT STUBBY IMPACT SOCKETS W/ HEX SHANK:(L:22.5mm)	6, 7, 8, 9, 10, 11, 12, 13, 14, 15, 16, 17, 18, 19 mm

## 11PC 1/2"DR. STUBBY IMPACT SOCKET SET (HEX SHANK) (mm)



1/2"



Item No.	11PC-SH3M
HOLDER IN BOX	L: 380 mm
WEIGHT	1 (kg)

CONTENT	
1/2"DR. 6PT STUBBY IMPACT SOCKETS W/ HEX SHANK:(L:28mm)	3/8", 7/16", 1/2", 9/16", 5/8", 11/16", 3/4", 13/16", 7/8", 15/16", 1"

## 15PC 1/2"DR. STUBBY IMPACT SOCKET SET (HEX SHANK) (SAE)



1/2"

Item No.	15PC-SH4M
HOLDER IN BOX	L: 480 mm
WEIGHT	1.25 (kg)

CONTENT	
1/2"DR. 6PT STUBBY IMPACT SOCKETS HEX SHANK:(L:28mm)	10, 11, 12, 13, 14, 15, 16, 17, 18, 19, 20, 21, 22, 23, 24 mm

## STUBBY 6 POINT IMPACT SOCKETS



- Only 22.5 mm (3/8"DR.)
- Ideal tool for transmission engine and interior work.
- Must have in every mechanics tool box for work in tight spaces.
- Built to perform with Mini Impact Gun.

# STAR IMPACT SOCKET

## STAR IMPACT SOCKET

### USA STYLE 1/4" DR STAR IMPACT SOCKET



1/4"



Item No.	S	L(mm)	D1(mm)	D2(mm)	G
IE26204	E4	25	12	6.2	10.3
IE26205	E5	25	12	7.2	10.9
IE26206	E6	25	12	8.2	11.1
IE26207	E7	25	12	9.0	11.4
IE26208	E8	25	12	10.3	12
IE26210	E10	25	13	12.5	15
IE26211	E11	25	14	13.2	24

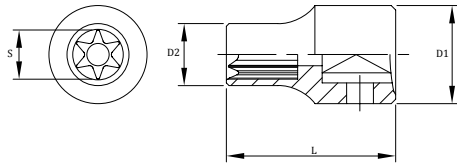

### USA STYLE 3/8" DR. STAR IMPACT SOCKET



3/8"



Item No.	S	L(mm)	D1(mm)	D2(mm)	G
IE36204	E4	28	17	7.3	18
IE36205	E5	28	17	8.3	19
IE36206	E6	28	17	9.3	20
IE36207	E7	28	17	10.0	21
IE36208	E8	28	17	11.2	21
IE36210	E10	28	17	13.2	23
IE36211	E11	28	17	13.8	24
IE36212	E12	28	17	14.8	22
IE36214	E14	28	18	16.8	30
IE36216	E16	28	20	18.8	39
IE36218	E18	28	22	20.8	48
IE36220	E20	28	24	22.8	50

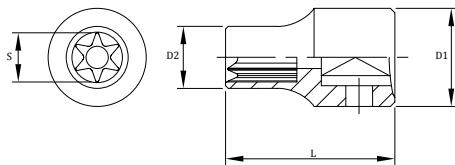

### USA STYLE 1/2" DR. STAR IMPACT SOCKET



1/2"



Item No.	S	L(mm)	D1(mm)	D2(mm)	G
IE46210	E10	38	22	13.2	49
IE46211	E11	38	22	13.9	50
IE46212	E12	38	22	15.0	51
IE46214	E14	38	22	16.7	53
IE46216	E16	38	22	18.8	56
IE46218	E18	38	22	20.8	59
IE46220	E20	38	24	23.0	73
IE46222	E22	38	26	25.0	88
IE46224	E24	38	28	27.0	109

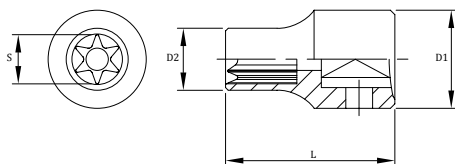

Socket & Wrench

Impact Socket

Air Chisels

Automotive Tools

# STAR IMPACT SOCKET

## EURO STYLE 1/4"DR. STAR IMPACT SOCKET



1/4"

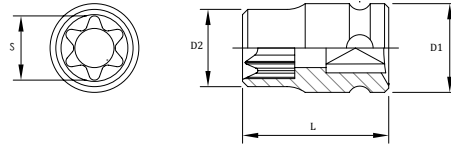

Item No.	S	L(mm)	D1(mm)	D2(mm)	G
IEMO26204	E4	25	13	7.2	12
IEMO26205	E5	25	13	8.2	12
IEMO26206	E6	25	13	9.0	13
IEMO26207	E7	25	13	9.4	13
IEMO26208	E8	25	13	10.2	14
IEMO26210	E10	25	13	12.4	15
IEMO26211	E11	25	13	13.0	24
IEMO26212	E12	25	14.5	14.5	30

## EURO STYLE 3/8"DR.STAR IMPACT SOCKET



3/8"

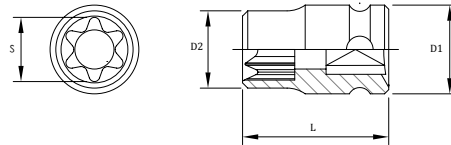

Item No.	S	L(mm)	D1(mm)	D2(mm)	G
IEMO36205	E5	32	19	8.9	19
IEMO36206	E6	32	19	10.2	20
IEMO36207	E7	32	19	10.2	21
IEMO36208	E8	32	19	10.4	21
IEMO36210	E10	32	19	12.4	36
IEMO36211	E11	32	19	14.5	38
IEMO36212	E12	32	19	15.0	38
IEMO36214	E14	32	19	17.5	38
IEMO36216	E16	32	19	19.0	41

## EURO STYLE 1/2"DR.STAR IMPACT SOCKET



1/2"

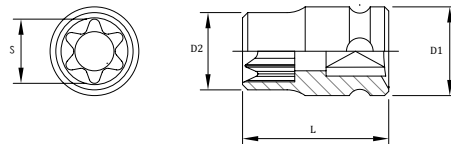

Item No.	S	L(mm)	D1(mm)	D2(mm)	G
IEMO46210	E10	38	25	13.0	80
IEMO46211	E11	38	25	14.0	80
IEMO46212	E12	38	25	15.2	80
IEMO46214	E14	38	25	17.0	80
IEMO46216	E16	38	25	18.5	80
IEMO46218	E18	38	25	20.6	80
IEMO46220	E20	38	30	22.6	80
IEMO46222	E22	45	30	24.6	91
IEMO46224	E24	45	30	26.4	95

## 1/4"DR. DEEP IMPACT STAR SOCKET



1/4"

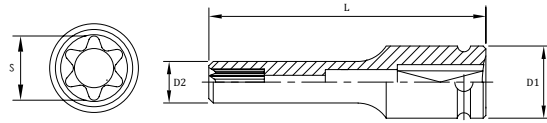

Item No.	S	L(mm)	D1(mm)	D2(mm)
IEL26204	E4	50	13	6.5
IEL26205	E5	50	13	7.5
IEL26206	E6	50	13	8.5
IEL26207	E7	50	13	9.2
IEL26208	E8	50	13	10.5
IEL26210	E10	50	13	12.5
IEL26211	E11	50	13	13

Socket & Wrench

Impact Socket

## 3/8"DR. DEEP IMPACT STAR SOCKET



3/8"

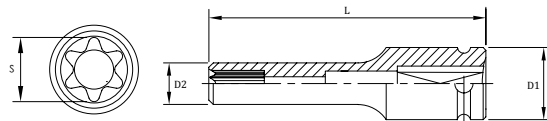

Item No.	S	L(mm)	D1(mm)	D2(mm)
IEL36204	E4	64	19	7.3
IEL36205	E5	64	19	8.3
IEL36206	E6	64	19	9.3
IEL36207	E7	64	19	10.0
IEL36208	E8	64	19	11.2
IEL36210	E10	64	19	13.2
IEL36212	E12	64	19	14.8
IEL36214	E14	64	19	16.8
IEL36216	E16	64	19	19

Air Chisels

Automotive Tools

## 1/2"DR. DEEP IMPACT STAR SOCKET



1/2"

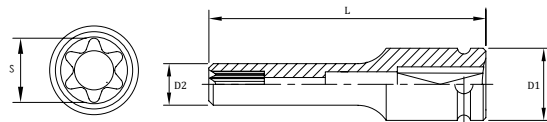

Item No.	S	L(mm)	D1(mm)	D2(mm)
IEL46210	E10	82	25	13.5
IEL46212	E12	82	25	15.5
IEL46214	E14	82	25	17.4
IEL46216	E16	82	25	19.3
IEL46218	E18	82	25	21.3
IEL46220	E20	82	25	23.3
IEL46222	E22	82	25	26
IEL46224	E24	82	25	28

# UNIVERSAL IMPACT SOCKET

## 17PC 3/8" & 1/2"DR. STAR IMPACT SOCKET SET



3/8"

1/2"



Item No.	17PC-07A-2
BLOW CASE	L:256 × W:148 × H:45 mm
WEIGHT	1200 (g)

CONTENT	
3/8"DR. STAR IMPACT SOCKET	E5, E6, E7, E8, E10, E12, E14, E16
1/2"DR. STAR IMPACT SOCKET	E10, E11, E12, E14, E16, E18, E20, E22, E24

## UNIVERSAL IMPACT SOCKET

### 3/8"DR. UNIVERSAL IMPACT SOCKET



3/8"

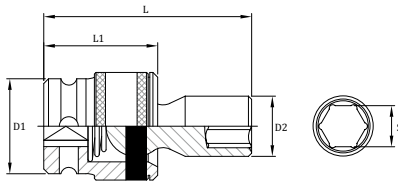

Item No.	S	L (mm)	L1 (mm)	D1 (mm)	D2 (mm)	G
CIUJK36112	3/8"	55	30	22	15	120
CIUJK36114	7/16"	55	30	22	17	124
CIUJK36116	1/2"	55	30	22	19	124
CIUJK36118	9/16"	55	30	22	21	128
CIUJK36120	5/8"	55	30	22	23	133
CIUJK36122	11/16"	55	30	22	25	138
CIUJK36124	3/4"	55	30	22	27	143

Item No.	S	L (mm)	L1 (mm)	D1 (mm)	D2 (mm)	G
CIUJK36210	10	55	30	22	15	119
CIUJK36211	11	55	30	22	17	124
CIUJK36212	12	55	30	22	19	126
CIUJK36213	13	55	30	22	19	126
CIUJK36214	14	55	30	22	21	128
CIUJK36215	15	55	30	22	22	132
CIUJK36217	17	55	30	22	25	140
CIUJK36218	18	55	30	22	25	140
CIUJK36219	19	55	30	22	27	143

### 3/8"DR. UNIVERSAL DEEP IMPACT SOCKET



3/8"

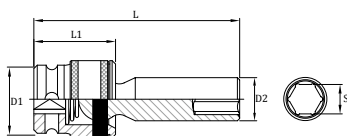

Item No.	S	L (mm)	L1 (mm)	D1 (mm)	D2 (mm)	G
CILUJK36112	3/8"	80	30	22	15	142
CILUJK36114	7/16"	80	30	22	17	151
CILUJK36116	1/2"	80	30	22	19	157
CILUJK36118	9/16"	80	30	22	21	169
CILUJK36120	5/8"	80	30	22	23	180
CILUJK36122	11/16"	80	30	22	25	194
CILUJK36124	3/4"	80	30	22	27	202

Item No.	S	L (mm)	L1 (mm)	D1 (mm)	D2 (mm)	G
CILUJK36210	10	80	30	22	15	140
CILUJK36211	11	80	30	22	17	152
CILUJK36212	12	80	30	22	19	162
CILUJK36213	13	80	30	22	19	155
CILUJK36214	14	80	30	22	21	170
CILUJK36215	15	80	30	22	22	176
CILUJK36217	17	80	30	22	25	197
CILUJK36218	18	80	30	22	25	197
CILUJK36219	19	80	30	22	27	202

## 1/2"DR. UNIVERSAL IMPACT SOCKET



1/2"

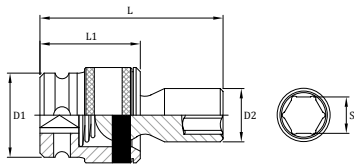

Item No.	S	L (mm)	L1 (mm)	D1 (mm)	D2 (mm)	G
CIUJK46116	1/2"	68	36	25	19	165
CIUJK46118	9/16"	68	36	25	22	165
CIUJK46120	5/8"	68	36	25	23	165
CIUJK46122	11/16"	68	36	30	26	228
CIUJK46124	3/4"	68	36	30	28	238
CIUJK46126	13/16"	68	36	30	30	246
CIUJK46128	7/8"	68	36	30	32	257
CIUJK46130	15/16"	68	36	30	32	264

Item No.	S	L (mm)	L1 (mm)	D1 (mm)	D2 (mm)	G
CIUJK46213	13	68	36	25	20	156
CIUJK46214	14	68	36	25	22	166
CIUJK46215	15	68	36	25	23	168
CIUJK46216	16	68	36	25	23	168
CIUJK46217	17	68	36	30	26	231
CIUJK46218	18	68	36	30	26	231
CIUJK46219	19	68	36	30	28	238
CIUJK46221	21	68	36	30	30	245
CIUJK46222	22	68	36	30	32	256
CIUJK46224	24	68	36	30	32	264

## 1/2"DR. UNIVERSAL DEEP IMPACT SOCKET



1/2"

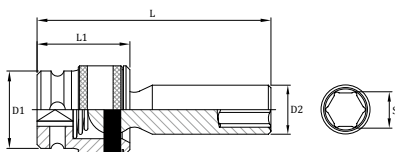

Item No.	S	L (mm)	L1 (mm)	D1 (mm)	D2 (mm)	G
CILUJK46116	1/2"	90	36	25	19	92
CILUJK46118	9/16"	90	36	25	22	114
CILUJK46120	5/8"	90	36	25	23	117
CILUJK46122	11/16"	90	36	30	26	149
CILUJK46124	3/4"	90	36	30	28	158
CILUJK46126	13/16"	90	36	30	30	180
CILUJK46128	7/8"	90	36	30	32	193
CILUJK46130	15/16"	90	36	30	32	340

Item No.	S	L (mm)	L1 (mm)	D1 (mm)	D2 (mm)	G
CILUJK46210	10	90	36	25	15	159
CILUJK46211	11	90	36	25	17	168
CILUJK46212	12	90	36	25	19	176
CILUJK46213	13	90	36	25	20	187
CILUJK46214	14	90	36	25	22	209
CILUJK46215	15	90	36	25	23	210
CILUJK46216	16	90	36	25	23	212
CILUJK46217	17	90	36	30	26	268
CILUJK46218	18	90	36	30	26	284
CILUJK46219	19	90	36	30	28	293
CILUJK46220	20	90	36	30	30	303
CILUJK46221	21	90	36	30	30	315
CILUJK46222	22	90	36	30	32	328
CILUJK46223	23	90	36	30	32	340
CILUJK46224	24	90	36	30	34	346

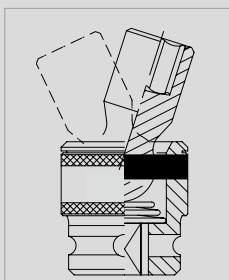

- Widely swing and smoothly move.
- Allow operation at a maximum angle of 30°

# UNIVERSAL IMPACT SOCKET

## 7PC 1/2"DR. IMPACT UNIVERSAL SOCKET SET (SAE)

6

1/2"



Item No.	7PC-61-4S
BLOW CASE METAL CASE	L:360 x W:140 mm
WEIGHT	325 (g)

### CONTENT

1/2"DR. 6PT IMPACT UNIVERSAL SOCKETS: 1/2", 9/16", 5/8", 11/16", 3/4", 13/16", 7/8"

## 9PC 1/2"DR. IMPACT UNIVERSAL SOCKET SET (mm)

6

1/2"



Item No.	7PC-47-4M
BLOW CASE METAL CASE	L:360 x W:140 mm
WEIGHT	400 (g)

### CONTENT

1/2"DR. 6PT IMPACT UNIVERSAL SOCKETS: 13, 14, 15, 16, 17, 18, 19, 21, 22 mm

# MAGNETIC IMPACT SOCKET

## MAGNETIC IMPACT SOCKET

### 1/4"DR. MAGNETIC IMPACT SOCKET



1/4"

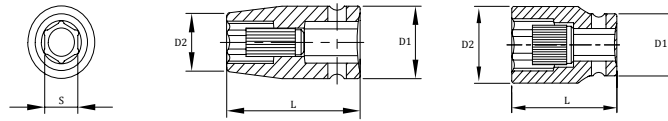

Item No.	S	L(mm)	D1(mm)	D2(mm)
CIDM26106	3/16"	13	23.0	8.4
CIDM26107	7/32"	13	23.0	9.4
CIDM26108	1/4"	13	23.0	10.3
CIDM26109	9/32"	13	23.0	11.3
CIDM26110	5/16"	13	23.0	12.3
CIDM26111	11/32"	13	23.0	13.4
CIDM26112	3/8"	13	23.0	14.5
CIDM26114	7/16"	13	23.0	16.3
CIDM26116	1/2"	13	23.0	18.3
CIDM26118	9/16"	13	23.0	19.6

Item No.	S	L(mm)	D1(mm)	D2(mm)
CIDM26205	5	13	23	8.7
CIDM2620505	5.5	13	23	9.3
CIDM26206	6	13	23	9.9
CIDM26207	7	13	23	11.1
CIDM26208	8	13	23	12.3
CIDM26209	9	13	23	13.8
CIDM26210	10	13	23	15.0
CIDM26211	11	13	23	16.3
CIDM26212	12	13	23	17.0
CIDM26213	13	13	23	18.8
CIDM26214	14	13	23	20.0
CIDM26215	15	13	23	21.0

### 3/8"DR. MAGNETIC IMPACT SOCKET



3/8"

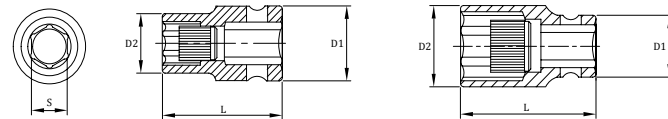

Item No.	S	L(mm)	D1(mm)	D2(mm)
CIDM36108	1/4"	19	29.5	10.6
CIDM36110	5/16"	19	29.5	12.6
CIDM36112	3/8"	19	29.5	14.6
CIDM36114	7/16"	19	29.5	17.1
CIDM36116	1/2"	19	29.5	20.0
CIDM36118	9/16"	19	29.5	21.0
CIDM36120	5/8"	22	30.0	23.5
CIDM36122	11/16"	22	30.0	25.0
CIDM36124	3/4"	22	30.0	27.0

Item No.	S	L(mm)	D1(mm)	D2(mm)
CIDM36207	7	19	29.5	11.4
CIDM36208	8	19	29.5	12.7
CIDM36209	9	19	29.5	14.0
CIDM36210	10	19	29.5	15.2
CIDM36211	11	19	29.5	17.0
CIDM36212	12	19	29.5	18.0
CIDM36213	13	22	29.5	19.3
CIDM36214	14	22	29.5	20.3
CIDM36215	15	22	29.5	22.0
CIDM36216	16	22	30.0	23.5
CIDM36217	17	22	30.0	25.0
CIDM36218	18	22	30.0	26.0
CIDM36219	19	22	30.0	27.0

### 1/2"DR. MAGNETIC IMPACT SOCKET



1/2"

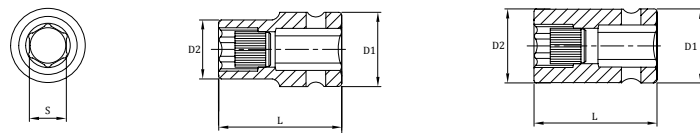

Item No.	S	L(mm)	D1(mm)	D2(mm)
CIDM46110	5/16"	25	38	14.5
CIDM46112	3/8"	25	38	16.0
CIDM46114	7/16"	25	38	18.0
CIDM46116	1/2"	25	38	20.0
CIDM46118	9/16"	25	38	22.0
CIDM46120	5/8"	25	38	25.0
CIDM46122	11/16"	25	38	26.0
CIDM46124	3/4"	25	38	28.0
CIDM46126	13/16"	25	38	30.0
CIDM46128	7/8"	30	38	32.0
CIDM46130	15/16"	30	42	34.0
CIDM46132	1"	30	42	36.0
CIDM46134	1-1/16"	30	46	38.0
CIDM46136	1-1/8"	30	46	40.0
CIDM46138	1-3/16"	30	46	42.0
CIDM46140	1-1/4"	30	46	44.0

Item No.	S	L(mm)	D1(mm)	D2(mm)
CIDM46208	8	38	14.5	25
CIDM46209	9	38	15.6	25
CIDM46210	10	38	16.7	25
CIDM46211	11	38	18.0	25
CIDM46212	12	38	19.0	25
CIDM46213	13	38	20.2	25
CIDM46214	14	38	21.5	25
CIDM46215	15	38	23.0	30
CIDM46216	16	38	24.5	30
CIDM46217	17	38	26.0	30
CIDM46218	18	38	27.0	30
CIDM46219	19	38	28.0	30
CIDM46220	20	38	29.2	30
CIDM46221	21	38	30.0	30

Socket & Wrench

Impact Socket

Air Chisels

Automotive Tools



# IMPACT ACCESSORIES

## IMPACT EXTENSION BAR

### 1/4" DR. IMPACT EXTENSION BAR

1/4"

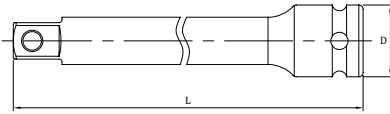

Item No.	L (inch)	L (mm)	D (mm)	G
IX202	2"	50	13	24
IX204	4"	100	13	44
IX206	6"	150	13	63

### 3/8" DR. IMPACT EXTENSION BAR

3/8"

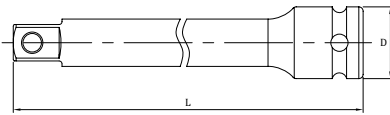

Item No.	L (inch)	L (mm)	D (mm)	G
IX303	3"	75	19	79
IX306	6"	150	19	148
IX310	10"	250	19	237

### 1/2" DR. IMPACT EXTENSION BAR

1/2"

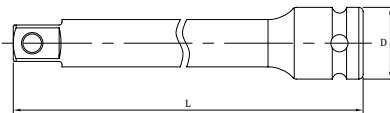

Item No.	L (inch)	L (mm)	D (mm)	G
IX402	2"	50	25	110
IX403	3"	75	25	143
IX405	5"	125	25	226
IX410	10"	250	25	427
IX415	15"	381	25	600

BALL TYPE



### 3/4" DR. IMPACT EXTENSION BAR

3/4"

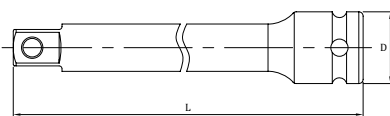

Item No.	L (inch)	L (mm)	D (mm)	G
IX604	4"	100	44	600
IX606	6"	150	44	790
IX607	7"	177	44	887
IX610	10"	250	44	1170
IX613	13"	330	44	1460

LOCK-HOLE TYPE



### 1" DR. IMPACT EXTENSION BAR

1"

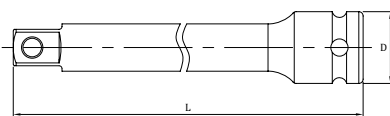

Item No.	L (inch)	L (mm)	D (mm)	G
IX804	4"	100	54	810
IX806	6"	150	54	1320
IX807	7"	175	54	1575
IX810	10"	250	54	1750
IX813	13"	330	54	2350

## WOBBLE IMPACT EXTENSION BAR

### 3/8"DR. WOBBLE IMPACT EXTENSION BAR

3/8"

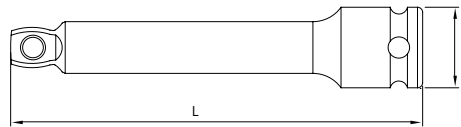

Item No.	L (inch)	L (mm)	D (mm)	G
IXW303	3"	75	12.2	76
IXW305	5"	125	12.2	120
IXW310	10"	250	12.2	233
IXW315	15"	381	12.2	356

### 3/8"DR. EXTENSION BAR

Item No.	L (inch)	L (mm)	D (mm)	G
IXW403	3"	75	16.5	143
IXW405	5"	125	16.5	226
IXW410	10"	250	16.5	427
IXW415	15"	381	16.5	648

## LOCK IMPACT EXTENSION BAR

### 1/4"DR. LOCK IMPACT EXTENSION BAR

1/4"

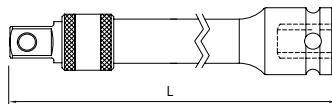
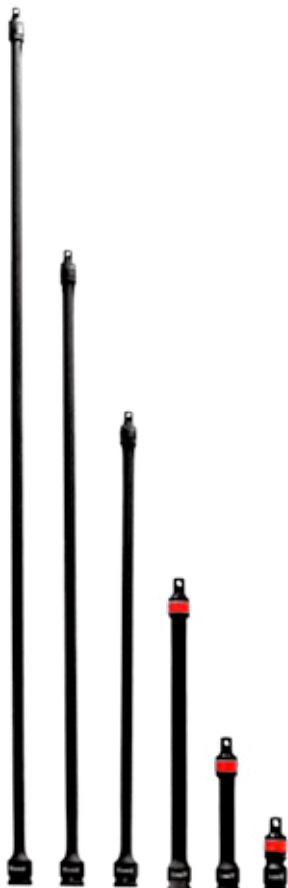

Item No.	L (inch)	L (mm)	G
CIXQ203	3"	75	33
CIXQ206	6"	150	63
CIXQ212	12"	300	126
CIXQ218	18"	457	198
CIXQ224	24"	610	263

### 3/8"DR. LOCK IMPACT EXTENSION BAR

3/8"

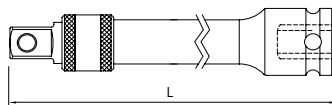

Item No.	L (inch)	L (mm)	G
CIXQ303	3"	75	71
CIXQ306	6"	150	140
CIXQ312	12"	300	277

### 1/2"DR. LOCK IMPACT EXTENSION BAR

1/2"

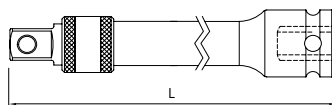

Item No.	L (inch)	L (mm)	G
CIXQ403	3"	75	131
CIXQ406	6"	150	255
CIXQ412	12"	300	502

Socket & Wrench

Impact Socket

Air Chisels

Automotive Tools

# IMPACT ACCESSORIES

## MAGNETIC IMPACT EXTENSION BAR

3/8"DR. MAGNETIC IMPACT EXTENSION BAR

3/8"

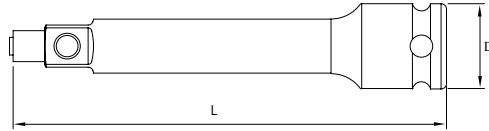

Item No.	L(inch)	L(mm)	D(mm)	G
IXM403	3"	75	19	79
IXM405	5"	125	19	125
IXM406	6"	150	19	148
IXM410	10"	250	19	237
IXM412	12"	305	19	280
IXM415	15"	381	19	360
IXM436	36"	914	19	792

1/2"DR. MAGNETIC IMPACT EXTENSION BAR

1/2"

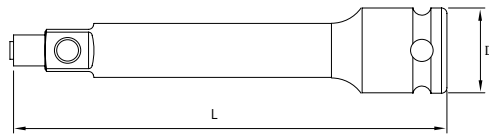

Item No.	L(inch)	L(mm)	D(mm)	G
IXM303	3"	75	25	140
IXM305	5"	125	25	226
IXM306	6"	150	25	255
IXM310	10"	250	25	430
IXM312	12"	305	25	502
IXM315	15"	381	25	600
IXM324	24"	610	25	1000
IXM336	36"	914	25	1500

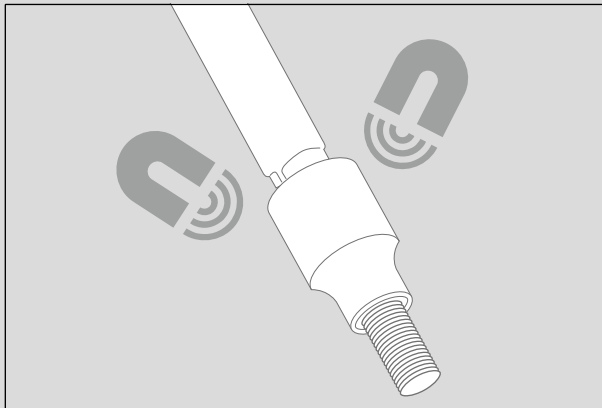

The top head of magnetic extension bar help turn every socket into a magnetic socket.

Hold nuts and bolts in place.



## IMPACT UNIVERSAL JOINT

IMPACT UNIVERSAL JOINT

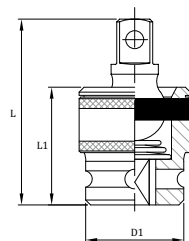

Item No.	S	L (mm)	L1	D1	G
CIUJ200	1/4"	44	25	13	38
CIUJ300	3/8"	50	30	22	93
CIUJ400	1/2"	63	36	30	194
CIUJ600	3/4"	90	53	44	610
CIUJ100	1"	115	65	54	1190

# SPINNING IMPACT EXTENSION BAR

## SPINNING IMPACT EXTENSION BAR

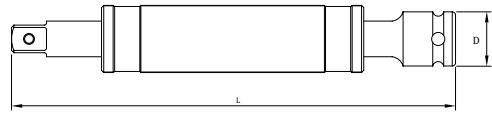

Item No.	S	D(mm)	L	G
CIXRT208	1/4"	13	8"	84
CIXRT308	3/8"	19	8"	190
CIXRT408	1/2"	25	8"	347
CIXRT610	3/4"	44	10"	1200
CIXRT810	1"	54	10"	2043



Spinning Impact Extension will totally give you brand new impression about impact extension. Ergonomic roller-bearing handle is toughly mounted to the impact extension.

- Protect your hand from friction burns.
- Give you a holding handle to help balance heavy impact tools.

## ADJUSTABLE SPINNING IMPACT EXTENSION BAR

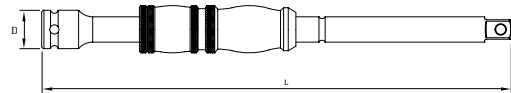

Item No.	S	D(mm)	Position	L	G
CIXART208	1/4"	13	2	8"	84
CIXART308	3/8"	19	2	8"	190
CIXART410	1/2"	25	3	10"	347
CIXART610	3/4"	44	3	10"	1173
CIXART810	1"	54	3	10"	2043

## ADJUSTABLE SPINNING IMPACT EXTENSIONS (Patent)

Spinning Stable



Adjustable Handle

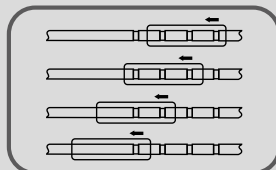

Efficient + Secure



- Fast Spinning than even before
- Security: protect your hand from friction burns
- Efficiency: Give you a holding handle to help balance heavy impact tools

# IMPACT ACCESSORIES

## IMPACT ADAPTER

### IMPACT ADAPTER

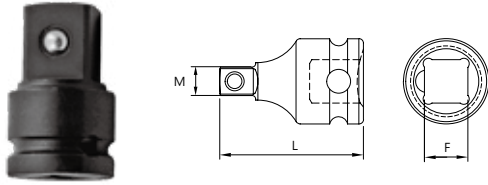

Item No.	F	M	L(mm)	G
IF302	3/8"	1/4"	32	30
IF403	1/2"	3/8"	38	69
IF604	3/4"	1/2"	56	343
IF806	1"	3/4"	75	695

Item No.	F	M	L(mm)	G
IF203	1/4"	3/8"	26	18
IF304	3/8"	1/2"	33	53
IF406	1/2"	3/4"	48	159
IF608	3/4"	1"	63	422
IF810	1"	1-1/2"	90	1500

### 5PC 3/4" & 1"DR. IMPACT ADAPTOR & IMPACT UNIVERSAL JOINT SET



Item No.	5PC-52A-SA
BLOW CASE	L:355 x W:151 x H:80 mm
WEIGHT	3.74 (kg)

#### CONTENT

3/4"DR. IMPACT UNIVERSAL JOINT.  
 1"DR. IMPACT UNIVERSAL JOINT.  
 3/4"(F)x1/2"(M) IMPACT ADAPTOR.  
 3/4"(F)x1"(M) IMPACT ADAPTOR.  
 1"(F)x3/4"(M) IMPACT ADAPTOR.

### 7PC 3/8" & 1/2"DR. IMPACT ADAPTOR & IMPACT UNIVERSAL JOINT & IMPACT EXTENSION BAR SET



Item No.	7PC-62
BLOW CASE	L:260 x W:115 x H:51 mm
WEIGHT	1.71 (kg)

#### CONTENT

3/8"DR. IMPACT UNIVERSAL JOINT.  
 1/2"DR. IMPACT UNIVERSAL JOINT.  
 3/8"(F)x1/2"(M) IMPACT ADAPTOR.  
 1/2"(F)x3/8"(M) IMPACT ADAPTOR.  
 1/2"(F)x3/4"(M) IMPACT ADAPTOR.  
 3/8"DR. 6" IMPACT EXTENSION BAR.  
 1/2"DR. 5" IMPACT EXTENSION BAR.

# IMPACT SOCKET SET

## 3/8"DR. IMPACT SOCKET SET

### 14PC 3/8"DR. IMPACT SOCKET SET (METRIC)



3/8"



Item No.	14PC-18M-2
BLOW CASE	L:200 × W:92 × H:42 mm
WEIGHT	750 (g)
<b>CONTENT</b>	
3/8"DR. 6-POINT IMPACT SOCKET	7, 8, 9, 10, 11, 12, 13, 14, 15, 16, 17, 18, 19

Socket & Wrench

Impact Socket

### 8PC 3/8"DR. DEEP IMPACT SOCKET SET (SAE)



3/8"



Item No.	8PC-48LS
BLOW CASE	L:200 × W:92 × H:42 mm
WEIGHT	850 (g)
<b>CONTENT</b>	
3/8"DR. 6-POINT DEEP IMPACT SOCKET	5/16", 3/8", 7/16", 1/2", 9/16", 5/8", 11/16", 3/4"

Air Chisels

Automotive Tools

## 1/2"DR. IMPACT SOCKET SET

### 10PC 1/2"DR. IMPACT SOCKET SET (METRIC)



1/2"

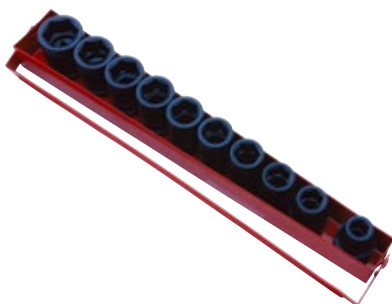

Item No.	10PC-14M-1
METAL TRAY	L:286 × W:24 × H:46 mm
WEIGHT	850 (g)
<b>CONTENT</b>	
1/2"DR. 6-POINT IMPACT SOCKET	10, 12, 13, 14, 15, 16, 17, 18, 19, 22

# IMPACT SOCKET SET

## 12PC 1/2"DR. IMPACT SOCKET SET (METRIC)



1/2"



Item No.	<b>12PC-37M-2</b>
BLOW CASE	L:260 × W:118 × H:50 mm
WEIGHT	1000 (g)

CONTENT	
1/2"DR. 6-POINT IMPACT SOCKET	10, 12, 13, 14, 15, 16, 17, 18, 19, 21, 22, 24

## 22PC 1/2"DR. IMPACT SOCKET SET (METRIC)



1/2"



Item No.	<b>22PC-09M-1</b>
BLOW CASE	L:270 × W:200 × H:60 mm
WEIGHT	4000 (g)

CONTENT	
1/2"DR. 6-POINT IMPACT SOCKET	10, 11, 12, 13, 14, 15, 16, 17, 18, 19, 20, 21, 22, 23, 24, 25, 26, 27, 28, 29, 30, 32

## 8PC 1/2"DR. DEEP IMPACT SOCKET SET (METRIC)



1/2"



Item No.	<b>8PC-37A-1</b>
BLOW CASE	L:270×W:168×H:50mm
WEIGHT	1250 (g)

CONTENT	
1/2"DR. 6-POINT DEEP IMPACT SOCKET	10, 11, 13, 17, 19, 21, 24, 27

## 12PC 1/2"DR. DEEP IMPACT SOCKET SET (METRIC)



1/2"



Item No.	<b>12PC-37LM-2</b>
BLOW CASE	L:500 × W:125 × H:68 mm
WEIGHT	1625 (g)

CONTENT	
1/2"DR. 6-POINT DEEP IMPACT SOCKET	10, 12, 13, 14, 15, 16, 17, 18, 19, 21, 22, 24

Socket & Wrench

Impact Socket

## 12PC 1/2"DR. IMPACT SOCKET SET (METRIC)



1/2"



Item No.	<b>12PC-44M-6PT</b>
BLOW CASE	L:366 × W:162 × H:88 mm
WEIGHT	3425 (g)

CONTENT	
1/2"DR. 6-POINT IMPACT SOCKET	23, 24, 25, 26, 27, 28, 30, 32, 33, 34, 35, 36

Air Chisels

Automotive Tools

## 12PC 1/2"DR. DEEP IMPACT SOCKET SET (METRIC)



1/2"



Item No.	<b>12PC-44LM-6PT</b>
BLOW CASE	L:355 × W:270 × H:76 mm
WEIGHT	5067 (g)

CONTENT	
1/2"DR. 6-POINT DEEP IMPACT SOCKET	23, 24, 25, 26, 27, 28, 30, 32, 33, 34, 35, 36



# IMPACT SOCKET SET

## 16PC 1/2"DR. IMPACT SOCKET SET (SAE)



1/2"



Item No.	<b>16PC-18S</b>
BLOW CASE	L:485 × W:355 × H:84 mm
WEIGHT	13900 (g)

CONTENT	
1/2"DR. 6-POINT IMPACT SOCKET	1-5/16", 1-3/8", 1-7/16", 1-1/2", 1-9/16", 1-5/8", 1-11/16", 1-3/4", 1-13/16", 1-7/8", 1-15/16", 2", 2-1/16", 2-1/8", 2-3/16", 2-1/4"

## 16PC 1/2"DR. DEEP IMPACT SOCKET SET (SAE)



1/2"



Item No.	<b>16PC-18LS</b>
BLOW CASE	L:560 × W:365 × H:90 mm
WEIGHT	18300 (g)

CONTENT	
1/2"DR. 6-POINT DEEP IMPACT SOCKET	1-5/16", 1-3/8", 1-7/16", 1-1/2", 1-9/16", 1-5/8", 1-11/16", 1-3/4", 1-13/16", 1-7/8", 1-15/16", 2", 2-1/16", 2-1/8", 2-3/16", 2-1/4"

## 19PC 1/2"DR. IMPACT SOCKET SET (SAE)



1/2"



Item No.	<b>19PC-14S</b>
BLOW CASE	L:271 × W:215 × H:60 mm
WEIGHT	5000 (g)

CONTENT	
1/2"DR. 6-POINT IMPACT SOCKET	3/8", 7/16", 1/2", 9/16", 5/8", 11/16", 3/4", 13/16", 7/8", 15/16", 1", 1-1/16", 1-1/8", 1-3/16", 1-1/4", 1-5/16", 1-3/8", 1-7/16", 1-1/2"



## 19PC 1/2"DR. DEEP IMPACT SOCKET SET (SAE)



1/2"



Item No.	<b>19PC-14LS</b>
BLOW CASE	L:381 × W:287 × H:80 mm
WEIGHT	9000 (g)

CONTENT	
1/2"DR. 6-POINT DEEP IMPACT SOCKET	3/8", 7/16", 1/2", 9/16", 5/8", 11/16", 3/4", 13/16", 7/8", 15/16", 1", 1-1/16", 1-1/8", 1-3/16", 1-1/4", 1-5/16", 1-3/8", 1-7/16", 1-1/2"

Socket &amp; Wrench

Impact Socket

## 26PC 1/2"DR. IMPACT SOCKET SET (METRIC)



1/2"



Item No.	<b>26PC-13M-1</b>
BLOW CASE	L:366 × W:162 × H:88 mm
WEIGHT	4950 (g)

CONTENT	
1/2"DR. 6-POINT IMPACT SOCKET	10, 11, 12, 13, 14, 15, 16, 17, 18, 19, 20, 21, 22, 23, 24, 25, 26, 27, 28, 29, 30, 32, 33, 34, 35, 36

Air Chisels

Automotive Tools

## 26PC 1/2"DR. DEEP IMPACT SOCKET SET (METRIC)



1/2"



Item No.	<b>26PC-13LM-1</b>
BLOW CASE	L:485 × W:355 × H:84 mm
WEIGHT	9800 (g)

CONTENT	
1/2"DR. 6-POINT DEEP IMPACT SOCKET	10, 11, 12, 13, 14, 15, 16, 17, 18, 19, 20, 21, 22, 23, 24, 25, 26, 27, 28, 29, 30, 32, 33, 34, 35, 36

# IMPACT SOCKET SET

## 22PC 1/2"DR. DEEP IMPACT SOCKET SET (METRIC)



1/2"



Item No.	22PC-09LM-3
BLOW CASE	L:381 × W:287 × H:80 mm
WEIGHT	8000 (g)

CONTENT	
1/2"DR. 6-POINT DEEP IMPACT SOCKET	10, 11, 12, 13, 14, 15, 16, 17, 18, 19, 20, 21, 22, 23, 24, 25, 26, 27, 28, 29, 30, 32

## 27PC 1/2"DR. DEEP IMPACT SOCKET SET (METRIC+SAE)



1/2"



Item No.	27PC-08LMS
BLOW CASE	L:447 × W:338 × H:84 mm
WEIGHT	5000 (g)

CONTENT	
1/2"DR. 6-POINT DEEP IMPACT SOCKET	10, 12, 13, 14, 15, 16, 17, 18, 19, 21, 22, 24
1/2"DR. 6-POINT DEEP IMPACT SOCKET	7/16", 1/2", 9/16", 5/8", 11/16", 3/4", 13/16", 7/8", 15/16, 1", 1-1/16, 1-1/8", 1-1/4"
1/2"DR. IMPACT EXTENSION BAR	5"
1/2"DR. IMPACT UNIVERSAL JOINT	

## 3/4"DR. IMPACT SOCKET SET

### 8PC 3/4"DR. DEEP IMPACT SOCKET SET (METRIC)



Item No.	<b>8PC-07LM</b>
BLOW CASE	L:383 × W:246 × H:67 mm
WEIGHT	5330 (g)

CONTENT	
3/4"DR. 6-POINT DEEP IMPACT SOCKET	26, 27, 29, 30, 32, 35, 36, 38

### 8PC 3/4"DR. DEEP IMPACT SOCKET SET (METRIC)



Item No.	<b>8PC-09M-1</b>
METAL CASE	L:278 × W:128 × H:95 mm
WEIGHT	8000 (g)

CONTENT	
3/4"DR. 6-POINT DEEP IMPACT SOCKET	22, 24, 27, 30, 32, 36, 38, 41

### 8PC 3/4"DR. IMPACT SOCKET SET (SAE)



Item No.	<b>8PC-49S</b>
METAL CASE	L:500 × W:125 × H:68 mm
WEIGHT	2333 (g)

CONTENT	
3/4"DR. 6-POINT IMPACT SOCKET	1", 1-1/16", 1-1/8", 1-1/4", 1-5/16", 1-3/8", 1-7/16", 1-1/2"

### 8PC 3/4"DR. IMPACT SOCKET SET (SAE)



Item No.	<b>8PC-49S1</b>
METAL CASE	L:355 × W:257 × H:94 mm
WEIGHT	11850 (g)

CONTENT	
3/4"DR. 6-POINT IMPACT SOCKET	2-1/16", 2-1/8", 2-3/16", 2-1/4", 2-5/16", 2-3/8", 2-7/16", 2-1/2"

Socket & Wrench

Impact Socket

Air Chisels

Automotive Tools

# IMPACT SOCKET SET

## 8PC 3/4"DR. IMPACT SOCKET SET (METRIC)



3/4"



Item No.	8PC-49M-1
BLACK BLOW CASE	L:520 x W:270 mm
WEIGHT	2000 (g)

CONTENT	
3/4"DR. 6PT IMPACT SOCKETS:	26, 27, 29, 30, 32, 35, 36, 38 mm

## 8PC 3/4"DR. DEEP IMPACT SOCKET SET (METRIC)



3/4"



Item No.	8PC-49ILM-1
BLACK BLOW CASE	L:500 x W:125 mm
WEIGHT	3170 (g)

CONTENT	
3/4"DR. 6PT DEEP IMPACT SOCKETS:	26, 27, 29, 30, 32, 35, 36, 38 mm

## 16PC 3/4"DR. IMPACT SOCKET SET (SAE)



3/4"



Item No.	16PC-13S
BLOW CASE	L:343 x W:283 x H:90 mm
WEIGHT	8.5 (kg)

CONTENT	
3/4"DR. 6-POINT IMPACT SOCKET	3/4", 13/16", 7/8", 15/16", 1", 1-1/16", 1-1/8", 1-1/4", 1-5/16", 1-3/8", 1-7/16", 1-1/2", 1-5/8", 1-3/4", 1-7/8", 2"

## 21PC 3/4"DR. IMPACT SOCKET SET (SAE)



3/4"



Item No.	<b>21PC-11S</b>
BLOW CASE	L:381 × W:287 × H:80 mm
WEIGHT	12.5 (kg)

CONTENT	
3/4"DR. 6-POINT IMPACT SOCKET	3/4", 13/16", 7/8", 15/16", 1", 1-1/16", 1-1/8", 1-3/16", 1-1/4", 1-5/16", 1-3/8", 1-7/16", 1-1/2", 1-9/16", 1-5/8", 1-11/16", 1-3/4", 1-13/16", 1-7/8", 1-15/16", 2"

Socket & Wrench

Impact Socket

## 8PC 3/4"DR. DEEP IMPACT SOCKET SET (SAE)



3/4"



Item No.	<b>8PC-49LS</b>
BLOW CASE	L:500 × W:125 × H:68 mm
WEIGHT	3.2 (kg)

CONTENT	
3/4"DR. 6-POINT DEEP IMPACT SOCKET	1", 1-1/16", 1-1/8", 1-1/4", 1-5/16", 1-3/8", 1-7/16", 1-1/2"

Air Chisels

Automotive Tools

## 14PC 3/4"DR. DEEP IMPACT SOCKET SET (SAE)



3/4"



Item No.	<b>14PC-19LS</b>
BLOW CASE	L:500 × W:125 × H:68 mm
WEIGHT	7.5 (kg)

CONTENT	
3/4"DR. 6-POINT DEEP IMPACT SOCKET	3/4", 13/16", 7/8", 15/16", 1", 1-1/16", 1-1/8", 1-3/16", 1-1/4", 1-5/16", 1-3/8", 1-7/16", 1-1/2", 1-5/8"

# IMPACT SOCKET SET

## 1" DR. IMPACT SOCKET SET

### 14PC 1"DR. IMPACT SOCKET SET (SAE)



1"



Item No.	<b>14PC-20S</b>
BLOW CASE	L:390 x W:310 x H:108 mm
WEIGHT	14.0 (kg)
<b>CONTENT</b>	
1"DR. 6-POINT IMPACT SOCKET	7/8", 15/16", 1", 1-1/16", 1-1/8", 1-3/16", 1-1/4", 1-15/16", 1-3/8", 1-1/2", 1-5/8", 1-3/4", 1-7/8", 2"

### 9PC 1"DR. DEEP IMPACT SOCKET SET (SAE)



1"



Item No.	<b>9PC-36LS</b>
BLOW CASE	L:390 x W:310 x H:108 mm
WEIGHT	11.5 (kg)
<b>CONTENT</b>	
1"DR. 6-POINT DEEP IMPACT SOCKET	1", 1-1/8", 1-1/4", 1-3/8", 1-1/2", 1-5/8", 1-3/4", 1-7/8", 2"

### 9PC 1"DR. IMPACT SOCKET SET (SAE)



1"



Item No.	<b>9PC-36S</b>
TWO COLOR BLOW CASE	L:355 x W:412 mm
WEIGHT	10 (kg)
<b>CONTENT</b>	
1"DR. 6PT IMPACT SOCKETS	1", 1-1/8", 1-1/4", 1-3/8", 1-1/2", 1-5/8", 1-3/4", 1-7/8", 2"

### 11PC 1"DR. DEEP IMPACT SOCKET SET (SAE)



1"



Item No.	<b>11PC-36LS</b>
TWO COLOR BLOW CASE	L:560 x W:412 mm
WEIGHT	26 (kg)
<b>CONTENT</b>	
1"DR. 6PT DEEP IMPACT SOCKETS	2-1/16", 2-1/8", 2-3/16", 2-1/4", 2-5/16", 2-3/8", 2-7/16", 2-1/2", 2-9/16", 2-5/8", 2-3/4"

## 16PC 1"DR. DEEP IMPACT SOCKET SET (SAE)

6

1"



Item No.	<b>16PC-16LS</b>
BLOW CASE	L:530 × W:350 × H:90 mm
WEIGHT	14.0 (kg)

CONTENT	
1"DR. 6-POINT DEEP IMPACT SOCKET	7/8", 15/16", 1", 1-1/16", 1-1/8", 1-13/16", 1-1/4", 1-15/16", 1-3/8", 1-7/16", 1-1/2", 1-5/8", 1-3/4", 1-13/16", 1-7/8", 2"

Socket & Wrench

Impact Socket

## 18PC 1"DR. IMPACT SOCKET SET (SAE)

6

1"



Item No.	<b>18PC-23S</b>
BLOW CASE	L:390 × W:310 × H:108 mm
WEIGHT	13.5 (kg)

CONTENT	
1"DR. 6-POINT IMPACT SOCKET	3/4", 13/16", 7/8", 15/16", 1", 1-1/16", 1-1/8", 1-3/16", 1-1/4", 1-15/16", 1-3/8", 1-7/16", 1-1/2", 1-5/8", 1-3/4", 1-13/16", 1-7/8", 2"

Air Chisels

Automotive Tools



# BITS IMPACT SOCKET

## HEX BIT IMPACT SOCKET

### 3/8"DR. HEX BIT IMPACT SOCKET (52L)

6

3/8"

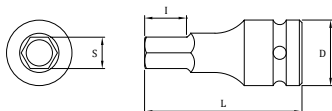

ItemNo.	S	L(mm)	I(mm)	D	G
IMBH3106	3/16"	52	12.0	19	38
IMBH3107	7/32"	52	12.5	19	38
IMBH3108	1/4"	52	13.0	19	40
IMBH3109	9/32"	52	13.5	19	43
IMBH3110	5/16"	52	14.0	19	47
IMBH3112	3/8"	52	15.0	19	54
IMBH3114	7/16"	52	15.5	19	60
IMBH3116	1/2"	52	15.5	19	70
IMBH3118	9/16"	52	16.0	19	74

ItemNo.	S	L(mm)	I(mm)	D	G
IMBH3203	H3	52	10.0	19	34
IMBH3204	H4	52	11.0	19	38
IMBH3205	H5	52	12.0	19	38
IMBH3206	H6	52	13.0	19	40
IMBH3207	H7	52	13.5	19	43
IMBH3208	H8	52	14.0	19	47
IMBH3209	H9	52	14.5	19	50
IMBH3210	H10	52	15.0	19	55
IMBH3212	H12	52	15.5	19	65
IMBH3214	H14	52	16.0	19	74

### 1/2"DR. HEX BIT IMPACT SOCKET (60L)

6

1/2"

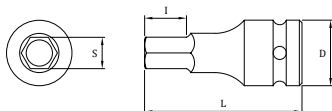

ItemNo.	S	L(mm)	I(mm)	D	G
IMBH4108	1/4"	60	13.0	25	70
IMBH4110	5/16"	60	14.0	25	78
IMBH4112	3/8"	60	15.0	25	87
IMBH4114	7/16"	60	15.5	25	100
IMBH4116	1/2"	60	15.5	25	110
IMBH4118	9/16"	60	16.0	25	117
IMBH4120	5/8"	60	17.0	25	130
IMBH4122	11/16"	60	17.5	25	150
IMBH4124	3/4"	60	18.0	25	157
IMBH4126	13/16"	60	18.0	25	170

ItemNo.	S	L(mm)	I(mm)	D	G
IMBH4204	H4	60	11.0	25	60
IMBH4205	H5	60	12.0	25	65
IMBH4206	H6	60	13.0	25	69
IMBH4207	H7	60	13.5	25	72
IMBH4208	H8	60	14.0	25	78
IMBH4209	H9	60	14.5	25	83
IMBH4210	H10	60	15.0	25	87
IMBH4212	H12	60	15.5	25	100
IMBH4214	H14	60	16.0	25	117
IMBH4216	H16	60	17.0	25	130
IMBH4217	H17	60	17.0	25	140
IMBH4218	H18	60	18.0	25	150
IMBH4219	H19	60	18.0	25	157
IMBH4221	H21	60	19.0	25	170

### 1/2"DR. HEX BIT IMPACT SOCKET (78L)

6

1/2"

ItemNo.	S	L(mm)	I(mm)	D	G
ILBH4108	1/4"	78	11.5	25	82
ILBH4110	5/16"	78	12	25	92
ILBH4112	3/8"	78	12.5	25	103
ILBH4114	7/16"	78	13	25	117
ILBH4116	1/2"	78	13	25	134
ILBH4118	9/16"	78	14	25	148
ILBH4120	5/8"	78	15	25	170
ILBH4122	11/16"	78	15.5	25	195
ILBH4124	3/4"	78	16	25	220
ILBH4126	13/16"	78	17	25	239

ItemNo.	S	L(mm)	I(mm)	D	G
ILBH4204	H4	78	11.0	25	70
ILBH4205	H5	78	12.0	25	76
ILBH4206	H6	78	13.0	25	80
ILBH4207	H7	78	13.5	25	84
ILBH4208	H8	78	14.0	25	93
ILBH4209	H9	78	14.5	25	100
ILBH4210	H10	78	15.0	25	104
ILBH4212	H12	78	15.5	25	130
ILBH4214	H14	78	16.0	25	148
ILBH4216	H16	78	17.0	25	160
ILBH4217	H17	78	17.0	25	189
ILBH4218	H18	78	18.0	25	200
ILBH4219	H19	78	18.0	25	214
ILBH4221	H21	78	19.0	25	225

## 3/4"DR. HEX BIT IMPACT SOCKET (88L)

6 3/4"

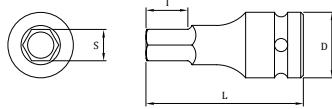

Item No.	S	L(mm)	l(mm)	D	G
ILBH6118	9/16"	88	18	44	440
ILBH6120	5/8"	88	20	44	445
ILBH6124	3/4"	88	22	44	467
ILBH6126	13/16"	88	22	44	462
ILBH6128	7/8"	88	24	44	520
ILBH6130	15/16"	88	24	44	545
ILBH6132	1"	88	26	44	568
ILBH6134	1-1/16"	88	26	44	606
ILBH6136	1-1/8"	88	30	44	567
ILBH6140	1-1/4"	88	30	44	726

Item No.	S	L(mm)	l(mm)	D	G
ILBH6214	H14	88	18	44	408
ILBH6217	H17	88	20	44	445
ILBH6219	H19	88	22	44	467
ILBH6221	H21	88	22	44	502
ILBH6222	H22	88	24	44	520
ILBH6224	H24	88	24	44	555
ILBH6227	H27	88	26	44	616
ILBH6230	H30	88	30	44	669
ILBH6232	H32	88	30	44	726

## 1"DR. HEX BIT IMPACT SOCKET

6 1"

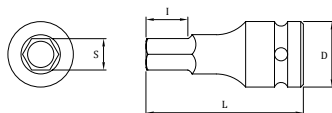

Item No.	S	L(mm)	l(mm)	D
ILBH8120	5/8"	100	20	54
ILBH8124	3/4"	100	20	54
ILBH8126	13/16"	100	20	54
ILBH8128	7/8"	100	20	54
ILBH8132	1"	100	20	54
ILBH8134	1-1/16"	100	20	54
ILBH8136	1-1/8"	100	20	54
ILBH8138	1-3/16"	100	20	54
ILBH8140	1-1/4"	100	20	54
ILBH8142	1-5/16"	100	20	54
ILBH8144	1-3/8"	100	20	54
ILBH8148	1-1/2"	100	20	54
ILBH8152	1-5/8"	100	20	54
ILBH8156	1-3/4"	100	20	54

Item No.	S	L(mm)	l(mm)	D
ILBH8214	H14	100	20	54
ILBH8217	H17	100	20	54
ILBH8219	H19	100	20	54
ILBH8222	H22	100	20	54
ILBH8224	H24	100	20	54
ILBH8227	H27	100	20	54
ILBH8230	H30	100	20	54
ILBH8233	H33	100	20	54
ILBH8236	H36	100	20	54
ILBH8238	H38	100	20	54
ILBH8241	H41	100	20	54

Socket & Wrench

Impact Socket

Air Chisels

Automotive Tools

# BITS IMPACT SOCKET

## 1-1/2"DR. HEX BIT IMPACT SOCKET

6 1-1/2"

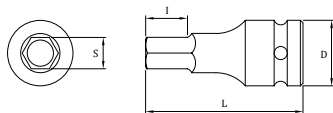

Item No.	S	L(mm)	l(mm)	D
ILBH10124	3/4"	120	20	86
ILBH10126	13/16"	120	20	86
ILBH10128	7/8"	120	20	86
ILBH10130	15/16"	120	20	86
ILBH10132	1"	120	20	86
ILBH10134	1-1/16"	120	20	86
ILBH10136	1-1/8"	120	20	86
ILBH10138	1-3/16"	120	20	86
ILBH10140	1-1/4"	120	20	86
ILBH10142	1-5/16"	120	20	86
ILBH10144	1-3/8"	120	20	86
ILBH10148	1-1/2"	120	20	86
ILBH10152	1-5/8"	120	20	86
ILBH10156	1-3/4"	120	20	86
ILBH10158	1-13/16"	120	20	86
ILBH10164	2"	120	20	86
ILBH10168	2-1/8"	120	20	86
ILBH10170	2-3/16"	120	20	86

Item No.	S	L(mm)	l(mm)	D
ILBH10219	H19	120	20	86
ILBH10222	H22	120	20	86
ILBH10224	H24	120	20	86
ILBH10227	H27	120	20	86
ILBH10230	H30	120	20	86
ILBH10232	H32	120	20	86
ILBH10233	H33	120	20	86
ILBH10236	H36	120	20	86
ILBH10238	H38	120	20	86
ILBH10241	H41	120	20	86
ILBH10246	H46	120	20	86
ILBH10250	H50	120	20	86
ILBH10255	H55	120	20	86

## 1/2"DR. UNIVERSAL HEX BIT IMPACT SOCKET

6 1/2"

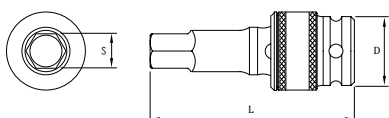

Item No.	S	L(mm)	D
IUJBH46206	6	75	28
IUJBH46208	8	75	28
IUJBH46210	10	75	28
IUJBH46212	12	75	28
IUJBH46214	14	75	28
IUJBH46215	15	75	28
IUJBH46217	17	75	28
IUJBH46218	18	75	28
IUJBH46219	19	75	28

Item No.	S	L(mm)	D
IUJBH46108	1/4"	75	28
IUJBH46110	5/16"	75	28
IUJBH46112	3/8"	75	28
IUJBH46114	7/16"	75	28
IUJBH46116	1/2"	75	28
IUJBH46118	9/16"	75	28
IUJBH46120	5/8"	75	28
IUJBH46124	3/4"	75	28

# STAR BIT IMPACT SOCKET

## 3/8"DR. STAR BIT IMPACT SOCKET (52L)

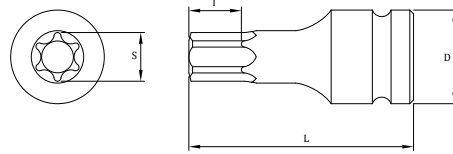

Item No.	S	L(mm)	I(mm)	D	G
IMB3T15	T15	52	2.50	19	32
IMB3T20	T20	52	2.60	19	33
IMB3T25	T25	52	2.80	19	34
IMB3T27	T27	52	3.10	19	35
IMB3T30	T30	52	3.40	19	37
IMB3T40	T40	52	3.70	19	40
IMB3T45	T45	52	4.00	19	43
IMB3T50	T50	52	4.80	19	46
IMB3T55	T55	52	5.40	19	54

## 3/8"DR. STAR BIT IMPACT SOCKET (100L)



Item No.	S	L(mm)	I(mm)	D	G
ILB3T15	T15	102	2.5	19	49
ILB3T20	T20	102	2.6	19	50
ILB3T25	T25	102	2.8	19	50
ILB3T27	T27	102	3.1	19	50
ILB3T30	T30	102	3.4	19	50
ILB3T40	T40	102	3.7	19	54
ILB3T45	T45	102	4.0	19	62
ILB3T50	T50	102	4.8	19	70
ILB3T55	T55	102	5.4	19	95

## 3/8"DR. STAR BIT IMPACT SOCKET (120L)



Item No.	S	L(mm)	I(mm)	D	G
ILBA3T15	T15	120	2.5	19	58
ILBA3T20	T20	120	2.6	19	58
ILBA3T25	T25	120	2.8	19	58
ILBA3T27	T27	120	3.1	19	58
ILBA3T30	T30	120	3.4	19	58
ILBA3T40	T40	120	3.7	19	63
ILBA3T45	T45	120	4.0	19	72
ILBA3T50	T50	120	4.8	19	83
ILBA3T55	T55	120	5.4	19	113

## 1/2"DR. STAR BIT IMPACT SOCKET (60L)

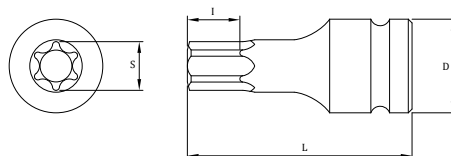

Item No.	S	L(mm)	I(mm)	D	G
IMB4T25	T25	60	8.0	25	70
IMB4T27	T27	60	8.0	25	70
IMB4T30	T30	60	8.0	25	70
IMB4T40	T40	60	8.5	25	70
IMB4T45	T45	60	9.5	25	70
IMB4T50	T50	60	10.5	25	75
IMB4T55	T55	60	11.5	25	86
IMB4T60	T60	60	13.0	25	95
IMB4T70	T70	60	14.0	25	105
IMB4T80	T80	60	16.0	25	113

Socket & Wrench

Impact Socket

Air Chisels

Automotive Tools

# BITS IMPACT SOCKET

## 1/2"DR. STAR BIT IMPACT SOCKET (78L)



1/2"



Item No.	S	L(mm)	I(mm)	D	G
ILB4T25	T25	78	8.0	25	66
ILB4T27	T27	78	8.0	25	67
ILB4T30	T30	78	8.0	25	71
ILB4T40	T40	78	8.5	25	79
ILB4T45	T45	78	9.5	25	84
ILB4T50	T50	78	10.5	25	88
ILB4T55	T55	78	11.5	25	104
ILB4T60	T60	78	13.0	25	118
ILB4T70	T70	78	14.0	25	134
ILB4T80	T80	78	16.0	25	151

## 1/2"DR. STAR BIT IMPACT SOCKET (100L)



1/2"

Item No.	S	L(mm)	I(mm)	D	G
ILBA4T25	T25	102	8.0	25	82
ILBA4T27	T27	102	8.0	25	84
ILBA4T30	T30	102	8.0	25	89
ILBA4T40	T40	102	8.5	25	99
ILBA4T45	T45	102	9.5	25	105
ILBA4T50	T50	102	10.5	25	110
ILBA4T55	T55	102	11.5	25	130
ILBA4T60	T60	102	13.0	25	147
ILBA4T70	T70	102	14.0	25	167
ILBA4T80	T80	102	16.0	25	189

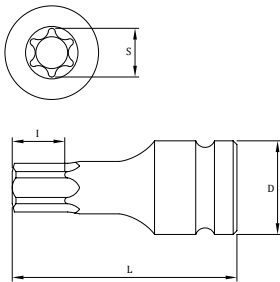

## 1/2"DR. STAR BIT IMPACT SOCKET (140L)



1/2"

Item No.	S	L(mm)	I(mm)	D	G
ILBB4T25	T25	140	8.0	25	94
ILBB4T27	T27	140	8.0	25	94
ILBB4T30	T30	140	8.0	25	94
ILBB4T40	T40	140	8.5	25	99
ILBB4T45	T45	140	9.5	25	110
ILBB4T50	T50	140	10.2	25	123
ILBB4T55	T55	140	11.5	25	158
ILBB4T60	T60	140	13.0	25	192
ILBB4T70	T70	140	14.0	25	232

# TRIPLE SQUARE TAMPERPROOF BIT IMPACT SOCKET

## 1/2"DR. TRIPLE SQUARE TAMPERPROOF BIT IMPACT SOCKET (60L)



1/2"

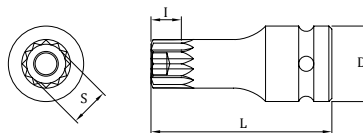

Item No.	S	L(mm)	I(mm)	D	G
IMB4M16H	M16H	60.00	14.00	25.00	107

# TRIPLE SQUARE BIT IMPACT SOCKET

## 3/8"DR. TRIPLE SQUARE BIT IMPACT SOCKET (52L)

**12** 3/8"



Item No.	S	L(mm)	l(mm)	D	G
IMB3M10	M10	52	8.5	19	48

## 3/8"DR. TRIPLE SQUARE BIT IMPACT SOCKET (100L)

**12** 3/8"

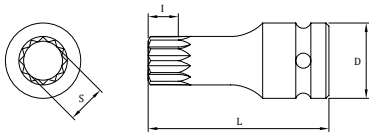

Item No.	S	L(mm)	l(mm)	D	G
ILB3M5	M5	102	5.0	19	51
ILB3M6	M6	102	6.0	19	52
ILB3M8	M8	102	8.0	19	57
ILB3M10	M10	102	8.5	19	76
ILB3M12	M12	102	8.5	19	96

## 3/8"DR. TRIPLE SQUARE BIT IMPACT SOCKET (120L)

**12** 3/8"

Item No.	S	L(mm)	l(mm)	D	G
ILBA3M5	M5	120	5.0	19	57
ILBA3M6	M6	120	6.0	19	59
ILBA3M8	M8	120	8.0	19	63
ILBA3M10	M10	120	8.5	19	87
ILBA3M12	M12	120	8.5	19	112

## 1/2"DR. TRIPLE SQUARE BIT IMPACT SOCKET (100L)

**12** 1/2"



Item No.	S	L(mm)	l(mm)	D	G
IMB4M14	M14	60	13	25	95

## 1/2"DR. TRIPLE SQUARE BIT IMPACT SOCKET (60L)

**12** 1/2"

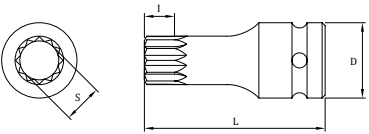

Item No.	S	L(mm)	l(mm)	D	G
ILBA4M5	M5	102	5.0	25	80
ILBA4M6	M6	102	6.0	25	81
ILBA4M8	M8	102	8.0	25	88
ILBA4M10	M10	102	8.5	25	105
ILBA4M12	M12	102	9.0	25	124
ILBA4M14	M14	102	9.5	25	145
ILBA4M16	M16	102	10.0	25	176
ILBA4M18	M18	102	11.0	25	176

## 1/2"DR. TRIPLE SQUARE BIT IMPACT SOCKET (140L)

**12** 1/2"

Item No.	S	L(mm)	l(mm)	D	G
ILBB4M5	M5	140	5.0	25	95
ILBB4M6	M6	140	6.0	25	96
ILBB4M8	M8	140	8.0	25	103
ILBB4M10	M10	140	8.5	25	131
ILBB4M12	M12	140	9.0	25	160
ILBB4M14	M14	140	9.5	25	192
ILBB4M16	M16	140	10.0	25	240
ILBB4M18	M18	140	11.0	25	240

Socket & Wrench

Impact Socket

Air Chisels

Automotive Tools

# BITS IMPACT SOCKET

## STAR BIT IMPACT SOCKET SET

9PC 3/8"DR. STAR BIT IMPACT SOCKET SET (52mm)



3/8"



Item No.	9PC-19A3
BLOW CASE	L:200 × W:92 × H:42 mm
WEIGHT	750 (g)

CONTENT	
3/8"DR. STAR IMPACT SOCKET (L:52mm)	T15, T20, T25, T27, T30, T40, T45, T50, T55

8PC 1/2"DR. STAR BIT IMPACT SOCKET SET (60mm)



1/2"



Item No.	8PC-02C-60L
BLOW CASE	L:260 × W:118 × H:50 mm
WEIGHT	1000 (g)

CONTENT	
1/2"DR. STAR IMPACT SOCKET (L:60mm)	T25, T27, T30, T40, T45, T50, T55, T60

8PC 1/2"DR. STAR BIT IMPACT SOCKET SET (78mm)



1/2"



Item No.	8PC-02C-78L
BLOW CASE	L:260 × W:118 × H:50 mm
WEIGHT	1200 (g)

CONTENT	
1/2"DR. STAR IMPACT SOCKET (L:78mm)	T25, T27, T30, T40, T45, T50, T55, T60

10PC 1/2"DR. STAR BIT IMPACT SOCKET SET (78mm)



1/2"



Item No.	10PC-51A
BLOW CASE	L:256 × W:148 × H:45 mm
WEIGHT	1500 (g)

CONTENT	
1/2"DR. STAR IMPACT SOCKET (L:78mm)	T25, T27, T30, T40, T45, T50, T55, T60, T70, T80

## HEX BIT IMPACT SOCKET SET

### 9PC 3/8"DR. HEX BIT IMPACT SOCKET SET (52mm)

6 3/8"



Item No.	9PC-19M
BLOW CASE	L:200xW:92xH:42 mm
WEIGHT	750 (g)

CONTENT	
3/8"DR. HEX IMPACT SOCKET (L:52mm)	H3, H4, H5, H6, H7, H8, H10, H12, H14

Socket & Wrench

Impact Socket

### 8PC 1/2"DR. HEX BIT IMPACT SOCKET SET (60mm)

6 1/2"



Item No.	8PC-01M-60L
BLOW CASE	L:260 x W:118 x H:50 mm
WEIGHT	1000 (g)

CONTENT	
1/2"DR. HEX IMPACT SOCKET (L:60mm)	H5, H6, H8, H10, H12, H14, H17, H19

Air Chisels

Automotive Tools

### 8PC 1/2"DR. HEX BIT IMPACT SOCKET SET (78mm)

6 1/2"



Item No.	8PC-01M-78L
BLOW CASE	L:260 x W:118 x H:50 mm
WEIGHT	1200 (g)

CONTENT	
1/2"DR. HEX IMPACT SOCKET (L:78mm)	H5, H6, H8, H10, H12, H14, H17, H19

### 8PC 1/2"DR. HEX BIT IMPACT SOCKET SET (78mm)

6 1/2"



Item No.	8PC-01S-78L
BLOW CASE	L:260 x W:118 x H:50 mm
WEIGHT	1400 (g)

CONTENT	
1/2"DR. HEX IMPACT SOCKET (L:78mm)	1/4", 5/16", 3/8", 7/16", 1/2", 9/16", 5/8", 3/4"



# BITS IMPACT SOCKET

## 16PC 1/2"DR. HEX BIT IMPACT SOCKET SET (78mm)

6 1/2"



Item No.	<b>16PC-15</b>
BLOW CASE	L:305 × W:220 × H:70 mm
WEIGHT	2900 (g)

CONTENT	
1/2"DR. HEX IMPACT SOCKET (L:78mm)	6, 7, 8, 10, 12, 14, 17, 19
1/2"DR. HEX IMPACT SOCKET (L:78mm) (IN)	1/4", 5/16", 3/8", 7/16", 1/2", 9/16", 5/8", 3/4"

## 5PC 3/4"DR. HEX BIT IMPACT SOCKET SET (88mm)

6 3/4"



Item No.	<b>5PC-01S-1</b>
BLOW CASE	L:270 × W:200 × H:60 mm
WEIGHT	3200 (g)

CONTENT	
3/4"DR. HEX IMPACT SOCKET (L:88mm) (IN)	5/8", 3/4", 7/8", 1", 1-1/4"

## 5PC 3/4"DR. HEX BIT IMPACT SOCKET SET (88mm)

6 3/4"



Item No.	<b>5PC-01M-2</b>
BLOW CASE	L:270 × W:200 × H:60 mm
WEIGHT	2665 (g)

CONTENT	
3/4"DR. HEX IMPACT SOCKET (L:88mm)	17, 19, 22, 24, 27

# ABOUT TIEN-I



Company Name	Tien-i Industrial Corporation Limited
Established Year	2004
Business Registration Code	80646988
Employee	100
Sales Representative	Candice Jiang   Ginny Lien   Ring Ku   Tannis Huang
Language	English, Mandarin
Country	Taiwan R.O.C.
Address	No. 43, Gongyequ 23rd Rd., Nantun Dist., Taichung City 40850, Taiwan (R.O.C.)
Factory Size	9000 Square Meter

## About Tien-i

In 2004, Larry Lee and Shaio-Pao partnered with 10 industry leaders to found Tien-I, a socket manufacturing firm based in Taichung, Taiwan. Having established a reputation for creating quality tools across the last 15 years, the company has continued to expand its product range and to nurture customer relationships. Presently, Tien-I supplies its global clients with over ten thousand items, including socket tool kits,

impact sockets, air chisels, tube tools, and automotive tools.

Clients include leading German and American tool brands in the aviation, automobile and solar industries, as well as Japanese machine companies. We consider ourselves more than a supplier—we would like to be your partner in creating an enduring brand.





# WHY TIEN-I

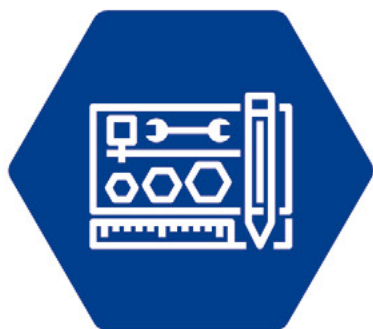

## CUSTOM SOCKET SET

Tien-i Taiwan Excellence Award-winning Team Provide a Variety of Customized Tool Sizes.



## FOR PRO BRANDS

Supply to Fortune 500 Companies. Top Tool Brands Assigned for the Aviation, High-tech Machine Company.



## TRANSPARENT FACTORY

With Secure Score from D&B Financial Report, Pass Intertek Factory Audit Pass, and Provide Trackable Quality Report.

## From Concept to Component

Tien-i's R&D engineering team specializes in manufacturing precision metal parts, especially cold forged and tube components. From the beginning of the design phase, the engineers work with our clients to transform the product concept into a manufacturable component.

Our engineers have the expertise to improve quality, accelerate time to market, and reduce waste. We offer consulting assistance to minimize cost without compromising on performance.



## Tailored for Your Market

Which tool kit is more successful in your market—the 446pc Master Tools Kit or the 36pc Professional Socket Set?

Decades of experience have shown us that the determining factors are: relevance of contents; and appeal and durability of packaging. With over 20,000 tools in our warehouse, Tien-i wholly customizes the contents of your tool sets. Based on the demands of your local market preference, our team will handpick the ideal selection of tools and packaging.

Exclusive molds are available on request.



## 100% Made in Taiwan for Pro Brands

In order to swiftly provide the products to companies all over the world, we are continuously increasing our manufacturing capacity in Taiwan. We have heavily invested in the machines

and molds to keep optimizing our production process. Managing our supply chain management via IT and ERP systems enables us to provide our global clients with over 20,000 SKU daily.

## Our Major Processes Include:

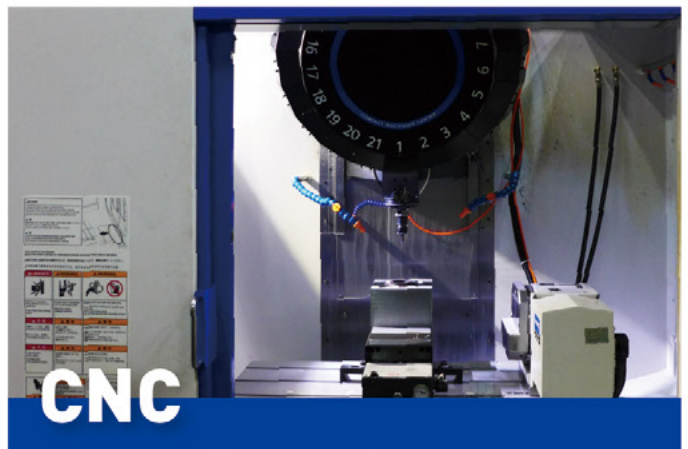
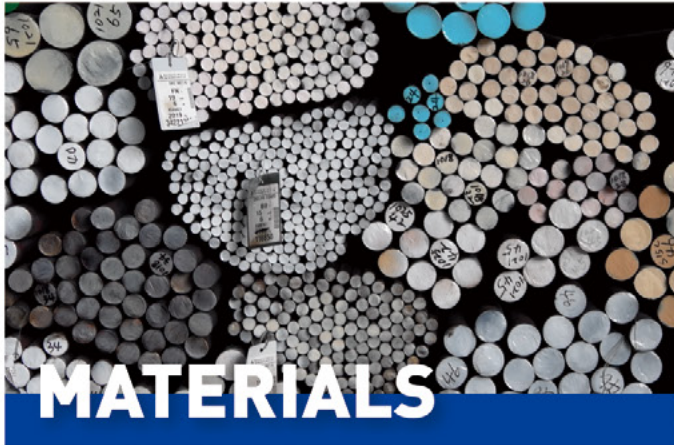



# QUALITY AND SAFETY ASSURANCE

To uphold the company's core values of integrity and reliability, Tien-I strives always to provide its clientele with tools of unsurpassed quality and meeting stringent safety standards. We have ISO 9001 and ROHS certification, and

our factories have passed the Intertek Audit. Each member of our quality control team has undergone SGS training to ensure that every Tien-I product satisfies DIN, ISO and ANSI/ASTM international standards.

## Our Certificate



ISO  
9001:2015



Supplier Qualification  
Program



Made in  
Taiwan



Taiwan  
Excellence

## Our Lab Equipment

1. Salt Spary Machine  
Test for Thickness of Plating
2. Torsion Test Machine  
Life-test & Ultimate Torque
3. Hardness Machines  
Test Material's Hardness
4. Optical Projector  
Measure Precise Dimension in  $\mu\text{m}$  Level
5. Measure Specification
6. Complete and Sophisticated Gauges
7. Standard, Key to Quality

